

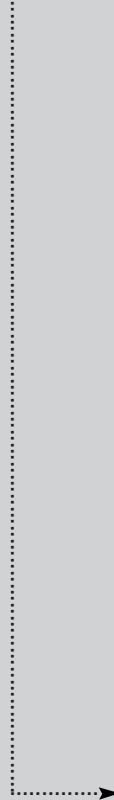

CSN2077DV

DVD TELEVISION



Owner's Instructions

Warning! Important Safety Instructions



CAUTION: TO REDUCE THE RISK OF ELECTRIC SHOCK, DO NOT REMOVE COVER (OR BACK). NO USER SERVICEABLE PARTS INSIDE. REFER SERVICING TO QUALIFIED SERVICE PERSONNEL.

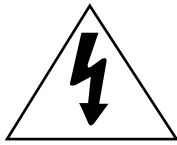

This symbol indicates high voltage is present inside. It is dangerous to make any kind of contact with any inside part of this product.



This symbol alerts you that important literature concerning operation and maintenance has been included with this product.

Note to CATV system installer: This reminder is provided to call CATV system installer's attention to Article 820-40 of the National Electrical Code (Section 54 of Canadian Electrical Code, Part I), that provides guidelines for proper grounding and, in particular, specifies that the cable ground shall be connected to the grounding system of the building as close to the point of cable entry as practical.

Caution: FCC/CSA regulations state that any unauthorized changes or modifications to this equipment may void the user's authority to operate it.

Caution: To prevent electric shock, match the wide blade of plug to the wide slot, and fully insert the plug.

Attention: pour éviter les chocs électriques, introduire la lame la plus large de la fiche dans la borne correspondante de la prise et pousser jusqu'au fond.

Important: One Federal Court has held that unauthorized recording of copyrighted TV programs is an infringement of U.S. copyright laws. Certain Canadian programs may also be copyrighted and any unauthorized recording in whole or in part may be in violation of these rights.

To prevent damage which may result in fire or electric shock hazard, do not expose this appliance to rain or moisture.

As an ENERGY STAR Partner,
Samsung Electronics America, Inc. has determined that this product or product model meets the ENERGY STAR guidelines for energy efficiency.

Thank You for Choosing Samsung

Thank you for choosing Samsung! Your new Samsung TV represents the latest in television technology. We designed it with easy-to-use on-screen menus and closed captioning capabilities, making it one of the best products in its class. We are proud to offer you a product that will provide convenient, dependable service and enjoyment for years to come.

Important Safety Information

 Always be careful when using your TV receiver. To reduce the risk of fire, electrical shock, and other injuries, keep these safety precautions in mind when installing, using, and maintaining your machine.

- Read all safety and operating instructions before operating your TV.
- Keep the safety and operating instructions for future reference.
- Heed all warnings on the TV receiver and in the operating instructions.
- Follow all operating and use instructions.
- Unplug the TV receiver from the wall outlet before cleaning. Use a damp cloth; do not use liquid or aerosol cleaners.
- Never add any attachments and/or equipment without approval of the manufacturer. Such additions can increase the risk of fire, electric shock, or other personal injury.
- Do not use the TV receiver where contact with or immersion in water is a possibility, such as near bath tubs, sinks, washing machines, swimming pools, etc.
- Do not place the TV on an unstable cart, stand, tripod, bracket, or table where it can fall. A falling TV can cause serious injury to a child or adult, and serious damage to the appliance. Use only with a cart, stand, tripod, bracket, or table recommended by the manufacturer or sold with the TV. Follow the manufacturer's instructions when mounting the unit, and use a mounting accessory recommended by the manufacturer. Move the TV and cart with care. Quick stops, excessive force, and uneven surfaces can make the unit and cart unsteady and likely to overturn.
- Provide ventilation for the TV receiver. The unit is designed with slots in the cabinet for ventilation to protect it from overheating. Do not block these openings with any object, and do not place the TV receiver on a bed, sofa, rug, or other similar surface. Do not place it near a radiator or heat register. If you place the TV receiver on a rack or bookcase, ensure that there is adequate ventilation and that you've followed the manufacturer's instructions for mounting.
- Operate your TV receiver only from the type of power source indicated on the marking label. If you are not sure of the type of power supplied to your home, consult your appliance dealer or local power company.
- Use only a grounded or polarized outlet. For your safety, this TV is equipped with a polarized alternating current line plug having one blade wider than the other. This plug will fit into the power outlet only one way. If you are unable to insert the plug fully into the outlet, try reversing the plug. If the plug still does not fit, contact your electrician to replace your outlet.



- Protect the power cord. Power supply cords should be routed so that they won't be walked on or pinched by objects placed on or against them. Pay particular attention to cords at plugs, convenience receptacles, and the point where they exit from the unit.
- Unplug the TV from the wall outlet and disconnect the antenna or cable system during a lightning storm or when left unattended and unused for long periods of time. This will prevent damage to the unit due to lightning and power-line surges.
- Avoid overhead power lines. An outside antenna system should not be placed in the vicinity of overhead power lines or other electric light or power circuits or where it can fall into such power lines or circuits. When installing an outside antenna system, be extremely careful to keep from touching the power lines or circuits. Contact with such lines can be fatal.
- Do not overload the wall outlet or extension cords. Overloading can result in fire or electric shock.
- Do not insert anything through the openings in the unit, where they can touch dangerous voltage points or damage parts. Never spill liquid of any kind on the TV.

- Ground outdoor antennas. If an outside antenna or cable system is connected to the TV, be sure the antenna or cable system is grounded so as to provide some protection against voltage surges and built-up static charges. Section 810 of the National Electrical Code, ANSI/NFPA No.70-1984, provides information about proper grounding of the mast and supporting structure, grounding of the lead-in wire to an antenna discharge unit, size of grounding conductors, location of antenna discharge unit, connection to grounding electrodes, and requirements for the grounding electrode.

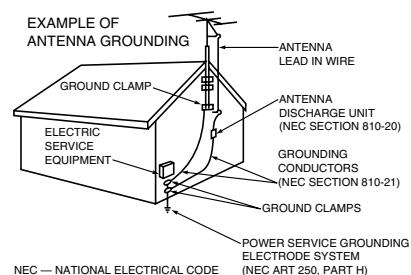

- Do not attempt to service the TV yourself. Refer all servicing to qualified service personnel. Unplug the unit from the wall outlet and refer servicing to qualified service personnel under the following conditions:
 - when the power-supply cord or plug is damaged
 - if liquid has been spilled on the unit or if objects have fallen into the unit
 - if the TV has been exposed to rain or water
 - if the TV does not operate normally by following the operating instructions
 - if the TV has been dropped or the cabinet has been damaged
 - when the TV exhibits a distinct change in performance
- If you make adjustments yourself, adjust only those controls that are covered by the operating instructions. Adjusting other controls may result in damage and will often require extensive work by a qualified technician to restore the TV to normal.
- When replacement parts are required, be sure the service technician uses replacement parts specified by the manufacturer or those that have the same characteristics as the original part. Unauthorized substitutions may result in additional damage to the unit.
- Upon completion of any service or repairs to this TV, ask the service technician to perform safety checks to determine that the TV is in a safe operating condition.

This device complies with part 15 of the FCC Rules. Operation is subject to the following two conditions:

- (1) This device may not cause harmful interference, and**
- (2) This device must accept any interference that may cause undesired operation.**

This television receiver provides display of television closed captioning in accordance with §15.119 of the FCC rules.

Chapter 1: Your New DVD/TV	1.1
List of Features	1.1
Familiarizing Yourself with Your New DVD/TV	1.2
Front Panel Buttons	1.2
Side Panel Jacks	1.3
Rear Panel Jacks	1.4
Remote Control	1.5
 Chapter 2: Installation	 2.1
Connecting VHF and UHF Antennas	2.1
Antennas with 300-ohm Flat Twin Leads	2.1
Antennas with 75-ohm Round Leads	2.1
Separate VHF and UHF Antennas.	2.2
Connecting Cable TV	2.2
Cable without a Cable Box	2.2
Connecting to a Cable Box that Descrambles All Channels.	2.2
Connecting to a Cable Box that Descrambles some Channels.	2.3
Connecting a VCR	2.4
Connecting a Second VCR to Record from the TV	2.5
Connecting a Camcorder	2.5
Connecting an Audio System	2.6
Installing Batteries in the Remote Control.	2.7
 Chapter 3: Operation	 3.1
Turning the TV On and Off	3.1
Viewing the Menus and On-Screen Displays.	3.1
Viewing the Menu.	3.1
Viewing the Display	3.1
Selecting a Menu Language	3.2
Memorizing the Channels.	3.3
Selecting the Video Signal-source	3.3
Storing Channels in Memory (Automatic Method).	3.4
Adding and Erasing Channels (Manual Method)	3.5
Changing Channels	3.6
Using the Channel Buttons.	3.6
Directly Accessing Channels	3.6
Using the Pre-CH Button to select the Previous Channel	3.6
Adjusting the Volume	3.7
Using Mute.	3.7
Setting the Clock	3.8
Customizing the Picture	3.9
Using Automatic Picture Settings	3.10
Customizing the Sound	3.11
Using Automatic Sound Settings	3.12
Viewing a VCR or Camcorder Tape.	3.13

Chapter 4: Special Features	4.1
Fine Tuning Channels	4.1
Digital Noise Reduction	4.2
Changing the Screen Size	4.3
Setting the On/Off Timer	4.5
Setting the Sleep Timer	4.7
Sound Features	4.8
Choosing a Multi-Channel Sound (MTS) track	4.8
Auto Volume	4.9
Bass Plus	4.10
Setting the On/Off Melody	4.11
Viewing Closed Captions	4.12
Using the V-Chip (USA Only)	4.13
Setting Up Your Personal ID Number (PIN)	4.13
How to Enable/Disable the V-Chip	4.14
How to Set up Restrictions Using the “TV guidelines”	4.14
How to Set up Restrictions using the MPAA Ratings: G, PG, PG-13, R, NC-17, X	4.16
How to Reset the TV after the V-Chip Blocks a Channel (“Emergency Escape”)	4.17
Chapter 5: DVD Operation	5.1
Playing a Disc	5.1
Using the Search and Skip Functions	5.3
Using the Display Function	5.4
Repeat Play	5.6
Program Play and Random Play	5.7
Using the Disc View Function (VCD)	5.8
Selecting the Audio Language	5.9
Selecting the Subtitle Language	5.11
Using the Master Volume Control Function	5.12
Changing the Camera Angle	5.13
Using the Zoom Function (DVD/VCD)	5.13
Using the Bookmark Function	5.14
MP3 Play	5.16
Setting up the Language Features	5.18
Setting up the Parental Control	5.20
Setting up the Audio Options	5.22
Setting up the Display Options	5.23
Disc Type and Characteristics	5.24
Chapter 6: Troubleshooting	6.1
Identifying Problems	6.1
Appendix	A.1
Cleaning and Maintaining Your TV	A.1
Using Your TV in Another Country	A.1
Specifications	A.1

Chapter One

YOUR NEW DVD/TV

List of Features

Your DVD/TV was designed with the latest technology. This DVD/TV is a high-performance unit that includes the following special features:

- Full Flat screen
- Easy-to-use remote control
- Easy-to-use on-screen menu system
- Automatic timer to turn the DVD/TV on and off
- Adjustable picture and sound settings that can be stored in the DVD/TV's memory
- Automatic channel tuning for up to 181 channels
- A special filter to reduce or eliminate reception problems
- Fine tuning control for the sharpest picture possible
- A built-in multi-channel sound decoder for stereo and bilingual listening
- Built-in, dual channel speakers
- A special sleep timer
- Headphone jack for private listening
- Melody feature
- DVD player

Familiarizing Yourself with The DVD/TV

Front Panel Buttons

The buttons on the front panel control your DVD/TV's basic features, including the on-screen menu. To use the more advanced features, you must use the remote control.

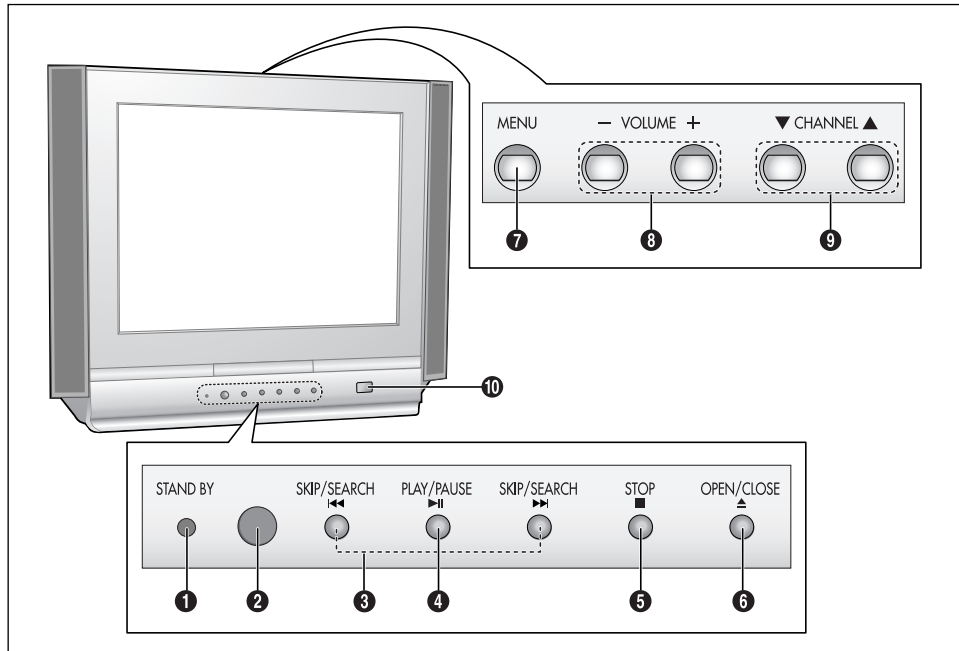

1 STAND BY

When the TV is turned on, the indicator is turned off.

2 Remote Control Sensor

Aim the remote control towards this spot on the TV.

3 SKIP/SEARCH

Press to skip or search the title, chapter or track.

4 PLAY/PAUSE

Press to play or pause the disc

5 STOP

Press to stop the disc

6 OPEN/CLOSE

Press to open and close the disc tray.

7 MENU

Press to see an on-screen menu of your TV's features.

8 VOLUME - , +

Press to increase or decrease the volume. Also used to select items on the on-screen menu.

9 CHANNEL ▼ and ▲

Press to change channels. Also press to highlight various items on the on-screen menu.

10 POWER

Press to turn the TV on and off.

Side Panel Jacks

You can use the side panel jacks to connect an A/V component that is used only occasionally, such as a camcorder or video game. (For information on connecting equipment, see pages 2.1 – 2.9.)

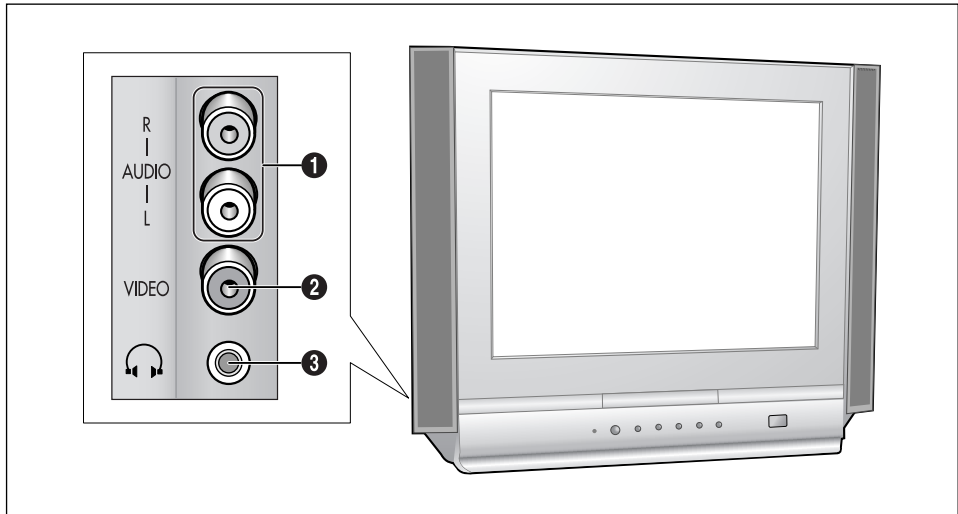

1 AUDIO IN jacks

Used to connect the audio signals from a camcorder or video game.

2 VIDEO IN jack

Used to connect a video signal from a camcorder or video game.

3 HEADPHONE JACK

Connect a set of external headphones to this jack for private listening.

Rear Panel Jacks

Use the rear panel jacks to connect an A/V component that will be connected continuously, such as a VCR or a camcorder.

For more information on connecting equipment, see pages 2.1 – 2.9.

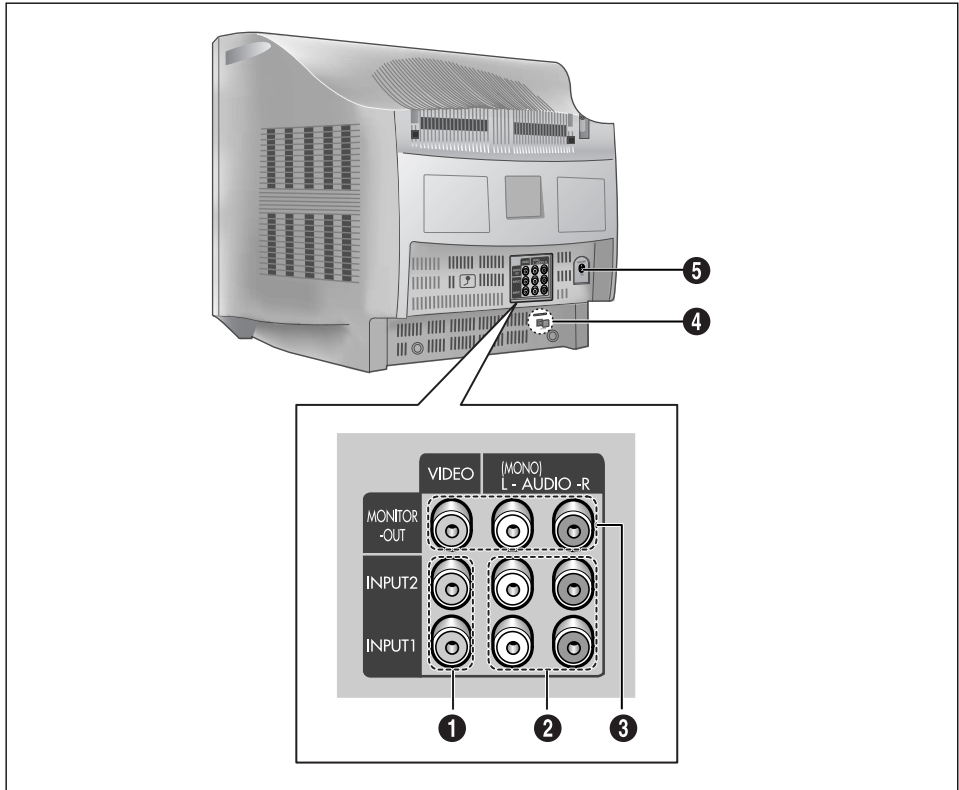

1 VIDEO INPUTS

Used to connect video signals from VCRs, laserdisc players and similar devices.

2 AUDIO INPUTS

Used to connect audio signals from VCRs, laserdisc players and similar devices.

3 AUDIO-VIDEO MONITOR OUTPUTS

Connect to the audio/video input jacks of a recording VCR.

4 DIGITAL AUDIO OUTPUT

Connect to a compatible dolby digital receiver.

5 VHF/UHF

Connect to an antenna or to a cable DVD/TV system.

Remote Control (TV Function Buttons)

You can use the remote control up to about 23 feet from the TV.
When using the remote, always point it directly at the TV.

- 1 POWER**
Turns the DVD/TV on and off.
- 2 +100**
Press to select channels over 100.
For example, to select channel 121, press "+100," then press "2" and "1."
- 3 VOL +, VOL -**
Press increase or decrease the volume.
- 4 MUTE**
Press to temporarily cut off the sound.
- 5 S.STD**
Adjust the TV sound by selecting one of the preset factory settings (or select your personal, customized sound settings).
- 6 P.STD**
Adjust the TV picture by selecting one of the preset factory settings (or select your personal, customized picture settings).
- 7 MENU**
Displays the main on-screen menu.
- 8 Control the cursor in the menu**
Allows move to items.

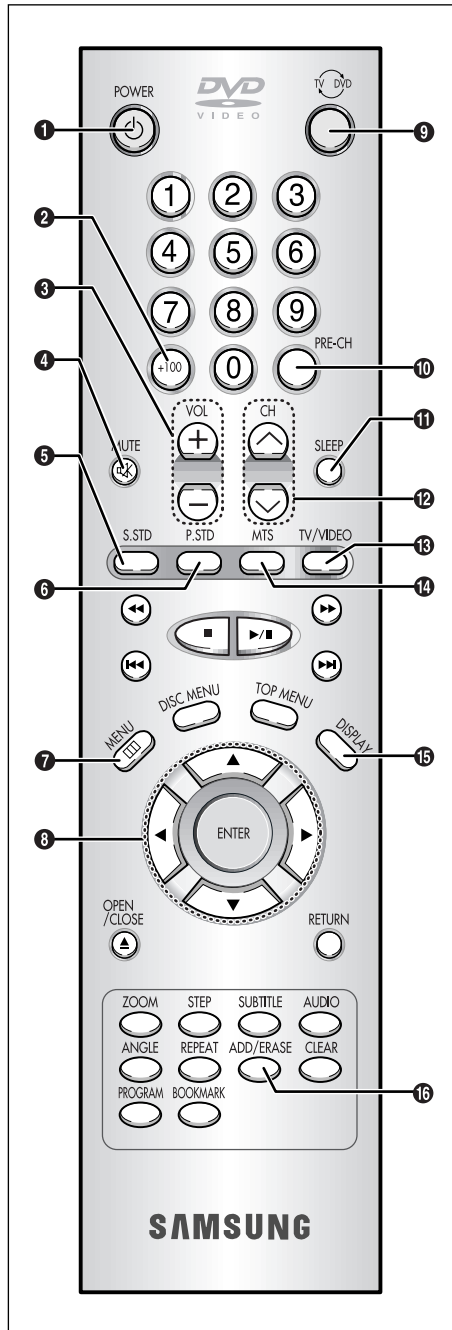

- 9 TV/DVD selection**
Press to switch between TV and DVD mode.
- 10 PRE-CH**
Tunes to the previous channel.
- 11 SLEEP**
Press to select a preset time interval for automatic shutoff.
- 12 CH∨ and CH∧ (Channel Down/Up)**
Press CH∨ or CH∧ to change channels.
- 13 TV/Video**
Press to watch the TV picture or a picture from a connected component (VCR, camcorder etc...)
- 14 MTS (Multichannel Television Stereo)**
Press to choose stereo, mono or Separate Audio Program (SAP broadcast).
- 15 DISPLAY**
Press to see the channel, time, current disc mode, audio/video settings etc., on-screen.
- 16 ADD/ERASE**
Press to add or erase channels in the TV's memory.

Remote Control (DVD Function Buttons)

- 1 Search**
Press to search forward/backward through a disc.
- 2 Stop**
Press to stop a disc.
- 3 DISC MENU**
Press to display the disc menu.
- 4 ENTER**
Confirms a selection.
- 5 OPEN/CLOSE**
Press to open or close the disc tray.
- 6 STEP**
Press to advance play one frame at a time.
- 7 ZOOM**
Press to zoom-in during playback, slow motion or pause mode on the selected area of a scene.
- 8 ANGLE**
Press to access various camera angles on a DVD.
- 9 PROGRAM**
For random and program play.
- 10 BOOKMARK**
Press to memorize scenes for replay.

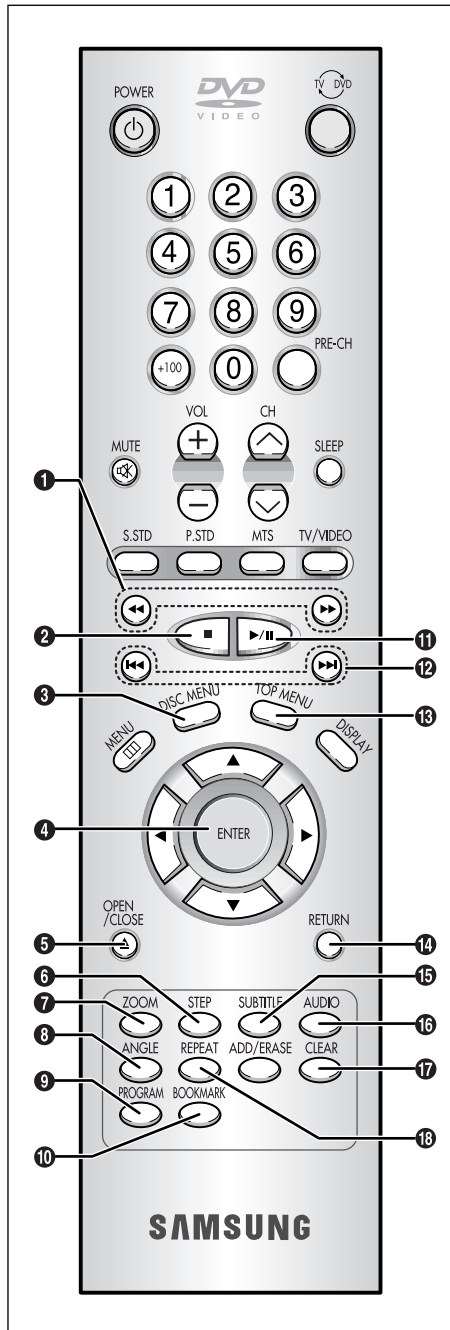

- 11 Play/pause**
Press to play or pause disc play.
- 12 Skip**
Press to skip the title, chapter, or track.
- 13 TOP MENU**
Press to display the top menu on a DVD or CD/VCD disc.
- 14 RETURN**
Press to return to a previous menu or exit.
- 15 SUBTITLE**
Press to display the subtitle language name abbreviation on-screen.
- 16 AUDIO**
Press to access various audio functions on a disc.
- 17 CLEAR**
Press to clear on-screen displays.
- 18 REPEAT**
Press to repeat play a title, chapter, track, or disc.

Chapter Two

INSTALLATION

Connecting VHF and UHF Antennas

If your antenna has a set of leads that look like this, see “Antennas with 300-ohm Flat Twin Leads,” below.

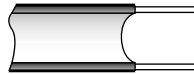

If your antenna has one lead that looks like this, see “Antennas with 75-ohm Round Leads,” on page 2.2.



If you have two antennas, see “Separate VHF and UHF Antennas,” on page 2.2.

Antennas with 300-ohm Flat Twin Leads

If you are using an off-air antenna (such as a roof antenna or “rabbit ears”) that has 300-ohm twin flat leads, follow the directions below.

1

Place the wires from the twin leads under the screws on the 300-75 ohm adaptor (not supplied). Use a screwdriver to tighten the screws.

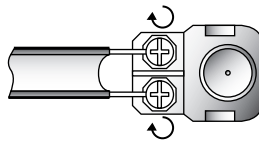

2

Plug the adaptor into the VHF/UHF terminal on the bottom of the back panel.

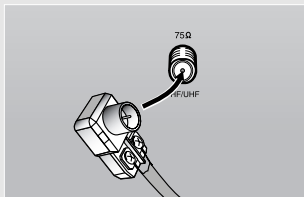

Antennas with 75-ohm Round Leads

1

Plug the antenna lead into the VHF/UHF terminal on the bottom of the back panel.

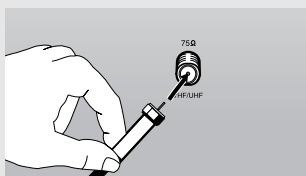

Separate VHF and UHF Antennas

If you have two separate antennas for your TV (one VHF and one UHF), you must combine the two antenna signals before connecting the antennas to the TV. This procedure requires a an optional combiner-adaptor (available at most electronics shops).

- 1 Connect both antenna leads to the combiner.

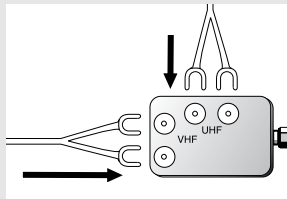

- 2 Plug the combiner into the VHF/UHF terminal on the bottom of the rear panel.

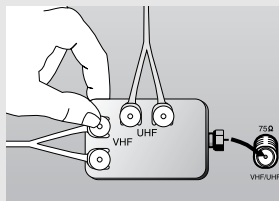

Connecting Cable TV

To connect to a cable TV system, follow the instructions below.

Cable without a Cable Box

- 1 Plug the incoming cable into the VHF/UHF antenna terminal on back of the TV.

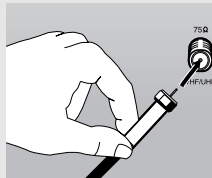

◀ Because this TV is cable-ready, you do not need a cable box to view unscrambled cable channels.

Connecting to a Cable Box that Descrambles All Channels

- 1 Find the cable that is connected to the ANTENNA OUT terminal on your cable box.

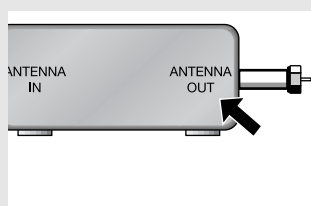

◀ This terminal might be labeled “ANT OUT,” “VHF OUT,” or simply, “OUT.”

- 2 Connect the other end of this cable to the VHF/UHF antenna terminal on the back of the TV.

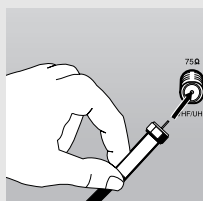

Connecting to a Cable Box that Descrambles Some Channels

If your cable box descrambles only some channels (such as premium channels), follow the instructions below. You will need a two-way splitter, an RF (A/B) switch, and four lengths of coaxial cable. (These items are available at most electronics stores.)

1
Find and disconnect the cable that is connected to the ANTENNA IN terminal on your cable box.

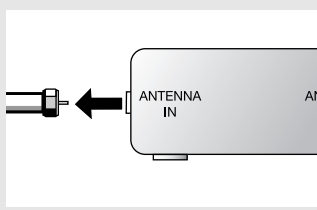

◀ This terminal might be labeled “ANT IN,” “VHF IN,” or simply, “IN.”

2
Connect this cable to a two-way splitter.

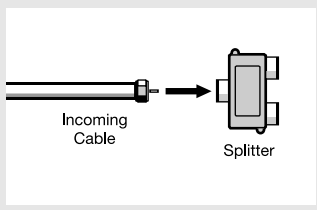

3
Connect a coaxial cable between an OUTPUT terminal on the splitter and the IN terminal on the cable box.

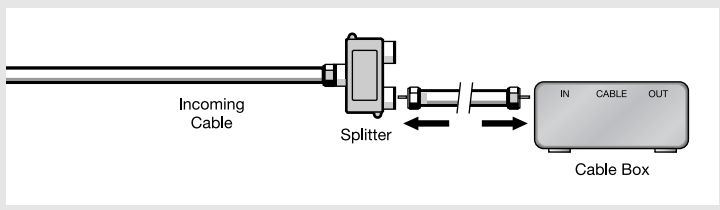

4
Connect a coaxial cable between the ANTENNA OUT terminal on the cable box and the B-IN terminal on the A/B switch.

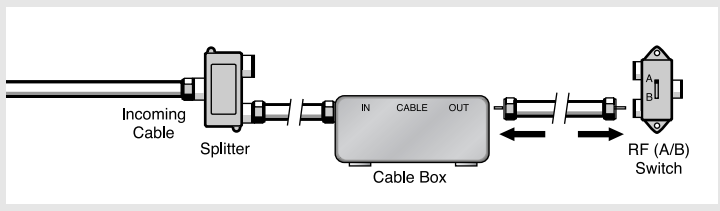

continued...

5

Connect another cable between the other OUT terminal on the splitter and the A-IN terminal on the RF (A/B) switch.

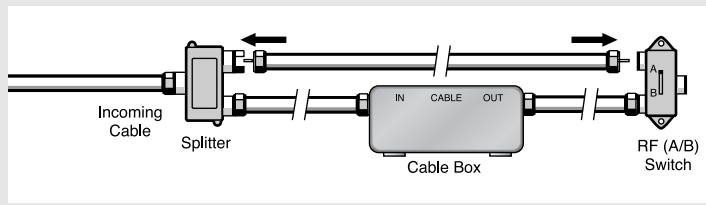

6

Connect the last coaxial cable between the OUT terminal on the RF (A/B) switch and the VHF/UHF terminal on the rear of the TV.

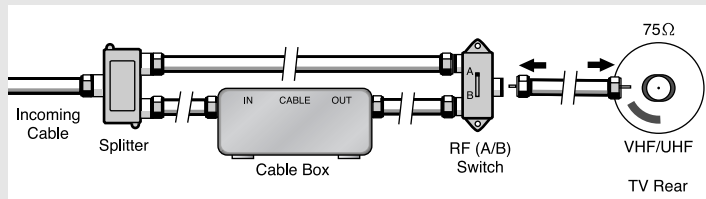

After you've made this connection, set the A/B switch to the "A" position for normal viewing. Set the A/B switch to the "B" position to view scrambled channels. (When you set the A/B switch to "B," you will need to tune your TV to the cable box's output channel, which is usually channel 3 or 4.)

Connecting a VCR

These instructions assume that you have already connected your TV to an antenna or a cable TV system (according to the instructions on pages 2.1-2.3). Skip step **1** if you have not yet connected to an antenna or a cable system.

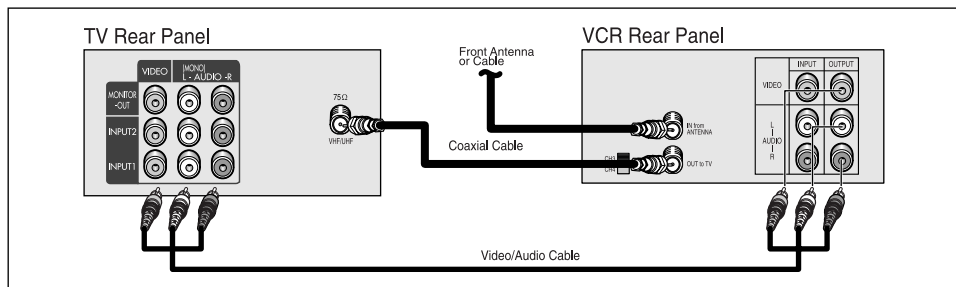

1

Connect a coaxial cable between the ANTENNA OUT terminal on the VCR and the antenna terminal on the TV. A coaxial cable is usually included with a VCR. (If not, check your local electronics store).

2

Connect a set of video/audio cables between the VIDEO/AUDIO OUT jacks on the VCR and the VIDEO/AUDIO jacks on the TV.

If you have a mono VCR, connect L(mono) to VCR audio out using only one audio cable. Follow the instructions in "Viewing a VCR or Camcorder Tape" on page 3.12 to view your VCR tape.

Connecting a Second VCR to Record from the TV

Your TV can send out signals of its picture and sound to be recorded by a second VCR.

To do this, connect your second VCR as follows:

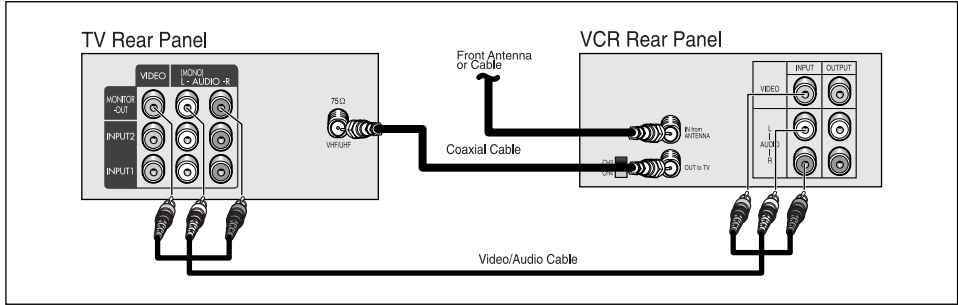

1

Connect a coaxial cable between the ANTENNA OUT terminal on the VCR and the antenna terminal on the TV. A coaxial cable is usually included with a VCR. (If not, check your local electronics store).

2

Connect a set of audio cables between the VIDEO/AUDIO OUT jacks on the TV and the VIDEO/AUDIO IN jacks on the VCR.

(The VCR input jacks might be either on the front or on back of the VCR.)

If you have a mono VCR, connect L(mono) to VCR audio out using only one audio cable.

Refer to your VCR's instructions for more information about how to record using this kind of connection.

Connecting a Camcorder

The side panel jacks on your TV make it easy to connect a camcorder to your TV. They allow you to view the camcorder tapes without using a VCR. (Also see "Viewing a VCR or Camcorder Tape" on page 3.17)

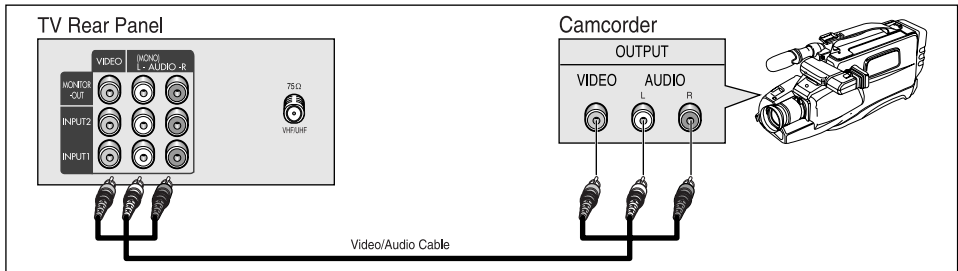

1

Locate the A/V output jacks on the camcorder. They are usually found on the side or rear of the camcorder.

2

Connect an video/audio cable between the VIDEO/AUDIO OUTPUT jack on the camcorder and the VIDEO/AUDIO terminals on the front of the TV.

If you have mono camcorder, connect L(mono) to camcorder audio out using only one audio cable.

The audio-video cables shown here are usually included with a Camcorder. (If not, check your local electronics store.) If your camcorder is stereo, you need to connect a set of two cables.

Connecting an Audio System (When playing a DVD)

The DIGITAL AUDIO OUT connector is used for equipment, such as an audio system (to take full advantage of the Surround sound effect).

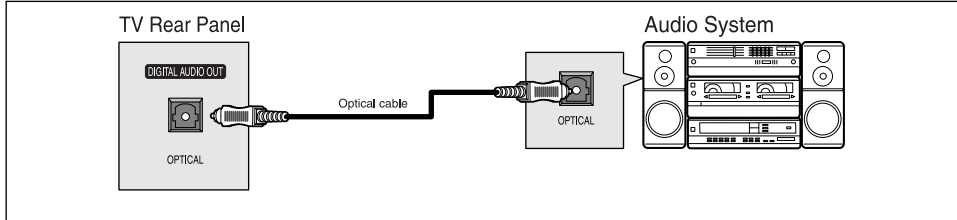

Connect an optical cable between the DIGITAL AUDIO IN jacks on the AUDIO and the DIGITAL AUDIO OUT jack on the TV.

Setting the Optical jack On/Off

1

Press the **MENU** button.

Press the UP/DOWN▲▼ buttons to select "Sound", then press the LEFT/RIGHT ◀▶ buttons.

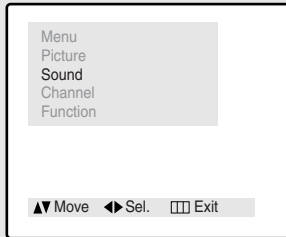

2

Press the UP/DOWN▲▼ buttons to select "Optical", then press the LEFT/RIGHT ◀▶ buttons to select "On" or "Off".

Press the **MENU** button to exit.

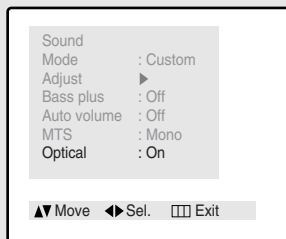

Note: The Optical On/Off function in the menu doesn't appear while a normal TV channel (RF channel) is being watched.

Installing Batteries in the Remote Control

1

Slide the cover out completely.

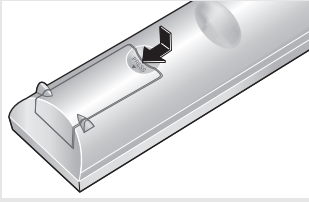

2

Install two AA size batteries.

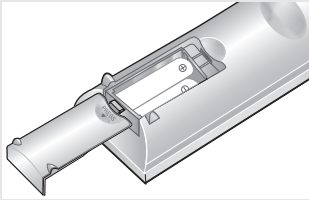

◀ Make sure to match the “+” and “-” ends of the batteries with the diagram inside the compartment.

3

Replace the cover.

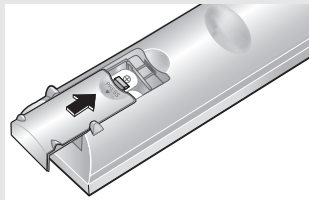

◀ Remove the batteries and store them in a cool, dry place if you won't be using the remote control for a long time.

The remote control can be used up to about 23 feet from the TV.

(Assuming typical TV usage, the batteries last for about one year.)

Chapter Three

OPERATION

Turning the TV On and Off

Press the **POWER** button on the remote control.
You can also use the Power button on the front panel.

Viewing the Menu and On-Screen Displays

Viewing the Menu

1
With the power on, press the **MENU** button.

The main menu appears on the screen:
Picture, Sound, Channel, Function and DVDP setup (in the DVD mode).

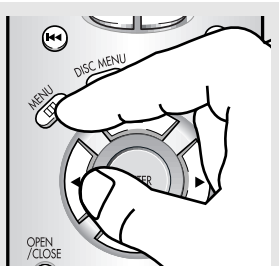

◀ The on-screen menu disappears from the screen after about thirty seconds.

2
Use the UP/DOWN▲▼ buttons to select one of the 5 items. Then press the LEFT/RIGHT ◀▶ buttons to access the item's sub-menu.

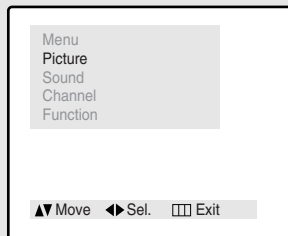

◀ You can also use the MENU, CHANNEL, and VOLUME buttons on the control panel of the TV to make selections.

3
Press the **MENU** button to exit.

Viewing the Display

The display identifies the current channel and the status of certain audio-video settings.

1
Press the **DISPLAY** button on the remote control.

The TV will display the channel, Time, disc mode, the status of certain picture and sound settings, V-chip and the type of sound.

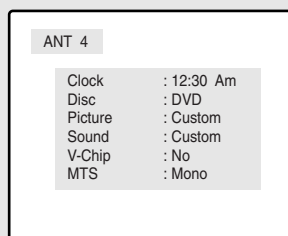

◀ The on-screen displays disappear after about ten seconds.

V-Chip: USA only

Selecting a Menu Language

1

Press the **MENU** button to display the menu.

Press the UP/DOWN▲▼ buttons to select "Function".
Press the LEFT/RIGHT◀▶ buttons.

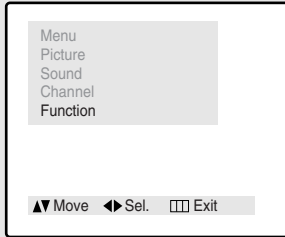

2

Press the UP/DOWN▲▼ buttons to select "Language".
Press the LEFT/RIGHT◀▶ buttons to select the appropriate language: English, Spanish, or French.

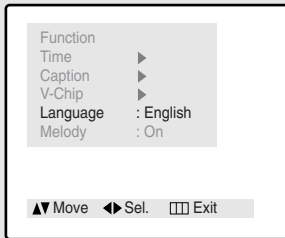

◀ V-Chip: USA only

3

Press the **MENU** button to exit.

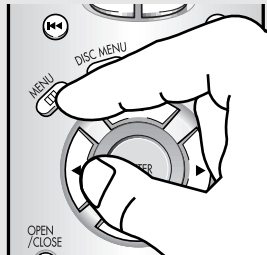

Memorizing the Channels

Your TV can memorize and store all of the available channels for both “off-air” (antenna) and cable channels. After the available channels are memorized, use the CH ▲ and CH ▼ buttons to scan through the channels. This eliminates the need to change channels by entering the channel digits. There are three steps for memorizing channels: selecting a broadcast source, memorizing the channels (automatic) and adding and deleting channels (manual).

Selecting the Video Signal-source

Before your television can begin memorizing the available channels, you must specify the type of signal source that is connected to the TV (i.e., an antenna or a cable system).

1

Press the **MENU** button to display the menu.

Press the **UP/DOWN▲▼** buttons to select “Channel”.

Press the **LEFT/RIGHT◀▶** buttons.

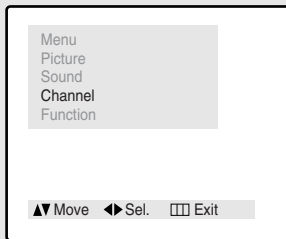

2

Press the **UP/DOWN▲▼** buttons to select “ANT/CATV”.

Repeatedly press the **LEFT/RIGHT◀▶** buttons to cycle through these choices:

ANT (antenna) STD, HRC or IRC (all cable TV).



Note: STD, HRC and IRC identify various types of cable TV systems. Contact your local cable company to identify the type of cable system that exists in your particular area.

At this point the signal source has been selected. Proceed to “Storing Channels in Memory” (next page).

Storing Channels in Memory (Automatic Method)

1

First, select the correct signal source (ANT, STD, HRC, IRC). See steps 1~2 on previous page.

Press the UP/DOWN▲▼ buttons to select "Channel", then press the LEFT/RIGHT◀▶ buttons.

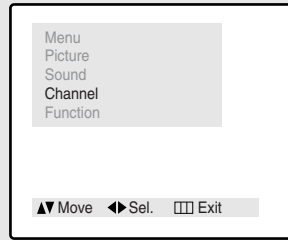

2

Press the UP/DOWN▲▼ buttons to select "Auto Program".

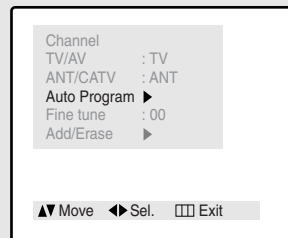

3

Press the LEFT/RIGHT◀▶ buttons. TV will begin memorizing all of the available channels.

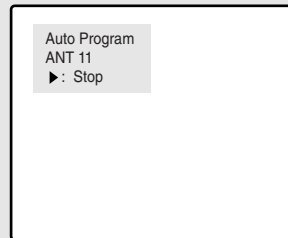

◀ The TV automatically cycles through all of the available channels and stores them in memory. This takes about one to two minutes.

Press the RIGHT▶ button at any time to interrupt the memorization process and return to the Channel menu.

4

After all the available channels are stored, the Auto program menu disappears. Press the **MENU** button to exit.

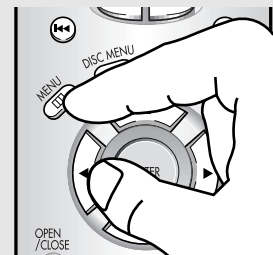

Adding and Erasing Channels (Manual Method)

1

Press the **MENU** button to display the menu.

Press the UP/DOWN▲▼ buttons to select "Channel".
Press the LEFT/RIGHT◀▶ buttons.

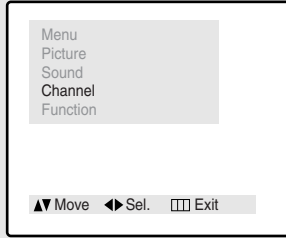

2

Press the UP/DOWN▲▼ buttons to select "Add/Erase".

Press the LEFT/RIGHT◀▶ buttons.



3

Press the LEFT/RIGHT◀▶ buttons or the number buttons to select the channel you want to add or erase.

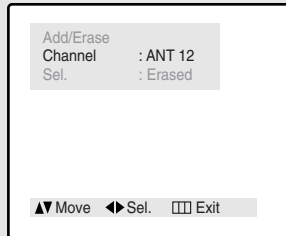

4

Press the UP/DOWN▲▼ buttons to select "Sel.".

Press the LEFT/RIGHT◀▶ buttons to select "Added" or "Erased".

Press the **MENU** button to exit.

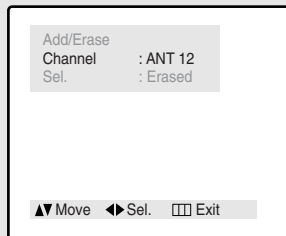

◀ You can view any channel (including an erased channel) by using the number buttons or UP/DOWN▲▼ buttons on the remote control.

Changing Channels

Using the Channel Buttons

Press the **CH** \downarrow or **CH** \uparrow buttons to change channels.

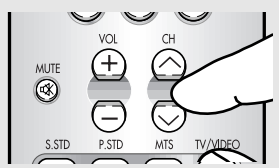

◀ When you press the **CH** \uparrow or **CH** \downarrow buttons, the TV changes channels in sequence. You will see all the channels that the TV has memorized. (The TV must have memorized at least three channels.) You will not see channels that were either erased or not memorized.

Directly Accessing Channels

Use the number buttons to quickly tune to any channel.

Press the number buttons to go directly to a channel. For example, to select channel 27, press “2,” then “7.” The TV will change channels when you press the second number.



When you use the number buttons, you can directly select channels that were either erased or not memorized.

To select a channel over 100, press the +100 button. (For channel 122, press “+100,” then “2,” then “2.”)

To change to single-digit channels (0–9) faster, press “0” before the single digit. (For channel “4,” press “0,” then “4.”)

Using the Pre-CH Button to select the Previous Channel

Press the **PRE-CH** button. The TV will switch to the last channel viewed.



◀ To quickly switch between two channels that are far apart, tune to one channel, then use the number button to select the second channel. Then, use the **PRE-CH** button to quickly alternate between them.

Adjusting the Volume

Press the **VOL +** or **VOL-** buttons to increase or decrease the volume.

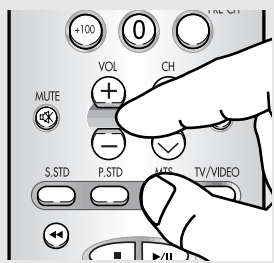

Using Mute

At any time, you can temporarily cut off the sound using the Mute button.

1

Press the **MUTE** button and the sound cuts off.

The word “Mute” will appear in the lower-left corner of the screen.

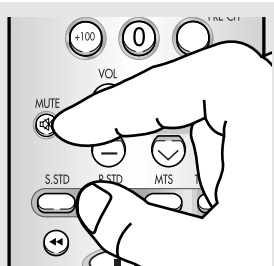

2

To turn mute off, press the **MUTE** button again, or simply press either the **VOL +** or **VOL-** buttons.

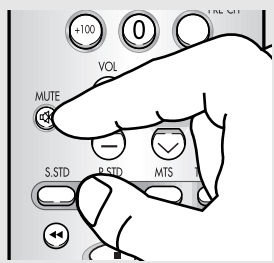

Setting the Clock

Setting the clock is necessary in order to use the various timer features of the TV. Also, you can check the time while watching the TV. (Just press DISPLAY.)

1

Press the **MENU** button to display the menu.

Press the UP/DOWN▲▼ buttons to select "Function", then press the LEFT/RIGHT ◀▶ buttons.

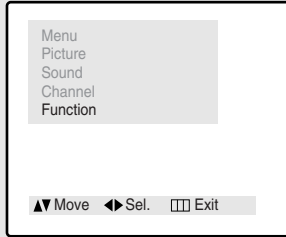

2

Press the LEFT/RIGHT ◀▶ buttons to select the Time.

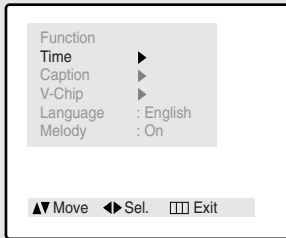

◀ V-Chip: USA only

3

Press the LEFT/RIGHT ◀▶ buttons again (the hours digits will be highlighted.)

Press the UP/DOWN▲▼ buttons repeatedly until the correct hour appears.

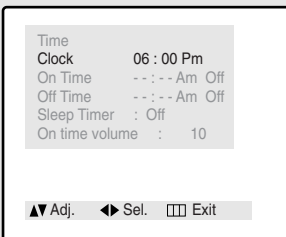

◀ When selecting the hours, be sure to select the proper time of day (AM or PM).

4

Press the LEFT/RIGHT ◀▶ buttons (the minute digits will be highlighted.)

Press the UP/DOWN▲▼ buttons repeatedly until the correct minute appears.

Press the **MENU** button to exit.

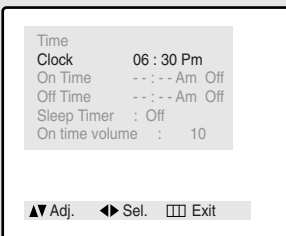

◀ The time will appear every time you press the DISPLAY button.

Customizing the Picture

You can use the on-screen menus to change the contrast, brightness, tint, color, and sharpness according to personal preference. (Alternatively, you can use one of the “automatic” settings. See next page.)

1

Press the **MENU** button to display the menu.

Press the **LEFT/RIGHT** ◀▶ buttons to display the Picture menu.

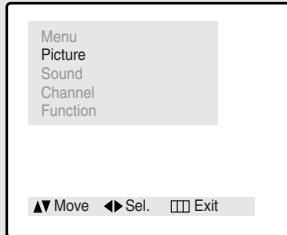

2

Press the **UP/DOWN** ▲▼ buttons to select “Adjust”, then press the **LEFT/RIGHT** ◀▶ buttons.



3

Press the **UP/DOWN** ▲▼ buttons to select particular item. Press the **LEFT/RIGHT** ◀▶ buttons increase or decrease the value of a particular item.

Press the **MENU** button to exit.

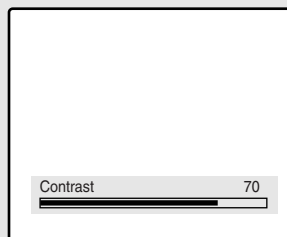

◀ After adjusting an item, the gauge will automatically disappear (after about 5 seconds).

Using Automatic Picture Settings

Your TV has three automatic picture settings (“Standard”, “Natural”, “Sports” and “Mild”) that are preset at the factory. You can activate either Standard, Natural, Sports or Mild by pressing P.STD (or by making a selection from the menu). Or, you can select “Custom” which automatically recalls your personalized picture settings.

1

Press the **MENU** button to display the menu.

Press the LEFT/RIGHT ◀▶ buttons to display the Picture menu.

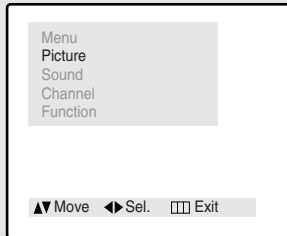

2

Press the LEFT/RIGHT ◀▶ buttons to select the “Standard,” “Natural,” “Sports,” “Mild,” or “Custom” picture setting.

Press the **MENU** button to exit.

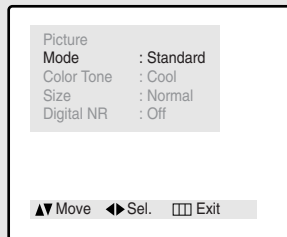

Alternate method:

Simply press the **P.STD** button on the remote control to select one of the standard picture settings.



- Choose *Standard* for the standard factory settings.
- Choose *Natural* for optimal indoor screen condition.
- Choose *Sports* for the realism and excitement of sports programs.
- Choose *Mild* (“Mild Contrast”) when viewing the TV in low light, or when playing video games.
- Choose *Custom* if you want to adjust the settings according to personal preference (see “Customizing the Picture, page 3.9).

Customizing the Sound

The sound settings can be adjusted to suit your personal preferences. (Alternatively, you can use one of the “automatic” settings. See next page.)

1
Press the **MENU** button to display the menu.

Press the UP/DOWN▲▼ buttons to select “Sound”, then press the LEFT/RIGHT◀▶ buttons.

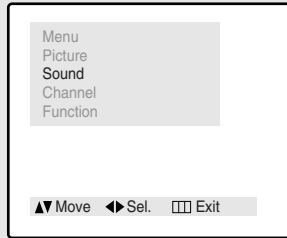

2
Press the UP/DOWN▲▼ buttons to select “Adjust”, then press the LEFT/RIGHT◀▶ buttons.

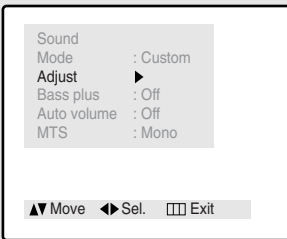

3
Press the UP/DOWN▲▼ buttons to select a particular item.

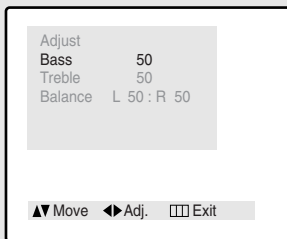

4
Press the LEFT/RIGHT◀▶ buttons increase or decrease the value of a particular item.

Press the **MENU** button to exit.

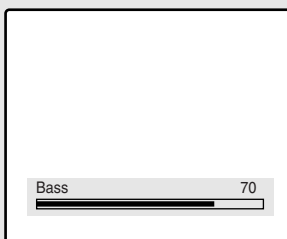

◀ After adjusting an item, the gauge will automatically disappear (after about 5 seconds).

Using Automatic Sound Settings

Your TV has four automatic sound settings (“Standard,” “Music,” “Movie” and “Speech”) that are preset at the factory. You can activate any of them by pressing the S.STD button (or by making a selection from the on-screen menu). Or, you can select “Adjust,” which automatically recalls your personalized sound settings.

1

Press the **MENU** button to display the menu.

Press the UP/DOWN▲▼ buttons to select “Sound”, then press the LEFT/RIGHT ◀▶ buttons.

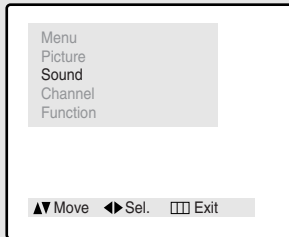

2

Press the LEFT/RIGHT ◀▶ buttons to select the “Standard,” “Music,” “Movie,” “Speech” or “Custom” sound setting.

Press the **MENU** button to exit.

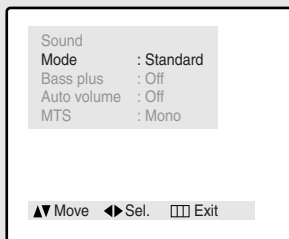

Alternate method:

Simply press the the **S.STD** button on the remote control to select one of the standard sound settings.

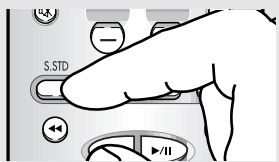

- Choose *Standard* for the standard factory settings.
- Choose *Music* when watching music videos or concerts.
- Choose *Movie* when watching movies.
- Choose *Speech* when watching a show that is mostly dialogue (i.e., news).
- Choose *Custom* to recall your personalized settings.

Viewing a VCR or Camcorder Tape

You must select the appropriate mode in order to view the VCR or Camcorder signal on the TV.

1

Press the **MENU** button to display the menu.

Press the UP/DOWN▲▼ buttons to select "Channel", then press the LEFT/RIGHT◀▶ buttons.

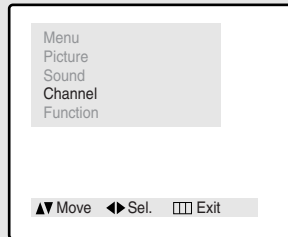

2

Press the LEFT/RIGHT◀▶ buttons. You will switch between viewing the signals coming from equipment connected to the TV's A/V jacks, and the TV signal.

Press the **MENU** button to exit.

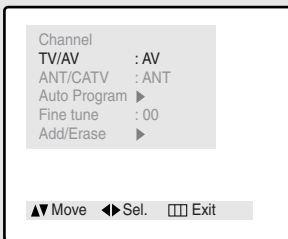

Alternate method:

Simply press the **TV/VIDEO** button on the remote control one or more times until the required input is displayed.

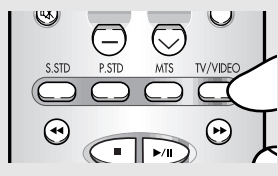

Chapter Four

SPECIAL FEATURES TV

Fine Tuning Channels

Use fine tuning to manually adjust a particular channel for optimal reception.

1

Select the appropriate channel.

Press the **MENU** button to display the menu.

Press the UP/DOWN▲▼ buttons to select "Channel".

Press the LEFT/RIGHT◀▶ buttons.



2

Press the UP/DOWN▲▼ buttons to select "Fine tune".

Press the LEFT/RIGHT◀▶ buttons to adjust the fine tuning.



3

To store the fine tuning setting in the TV's memory, press the **UP ▲** button. (An asterisk "*" will appear.)

To reset the fine tuning to "00," press the **DOWN ▼** button.

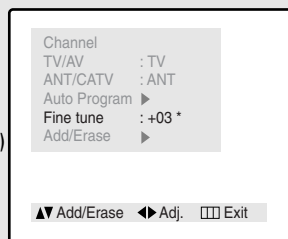

◀ After you adjust the fine tuning, an asterisk "*" will appear when you press DISPLAY while watching this channel.

4

Press the **MENU** button to exit.

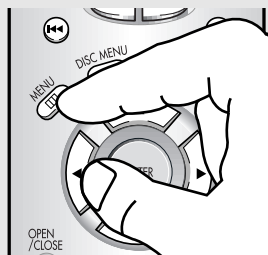

Digital Noise Reduction

If the broadcast signal received by your TV is weak, you can activate the Digital Noise Reduction feature to help reduce any static and ghosting that may appear on the screen.

1

Press the **MENU** button to display the menu.

Press the **LEFT/RIGHT** ◀▶ buttons to display the Picture menu.

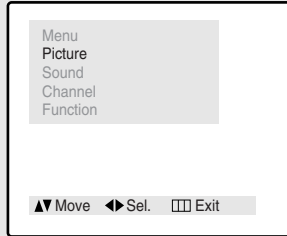

2

Press the **UP/DOWN** ▲▼ buttons to select "Digital NR".

Press the **LEFT/RIGHT** ◀▶ buttons to select Digital NR "On".

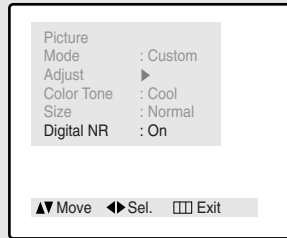

◀▶ Pressing the **LEFT/RIGHT** ◀▶ buttons will alternate between "On" and "Off".

3

Press the **MENU** button to exit.

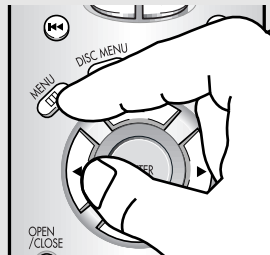

Changing the Screen Size

1

Press the **MENU** button to display the menu.

Press the **LEFT/RIGHT** ◀▶ buttons to display the Picture menu.

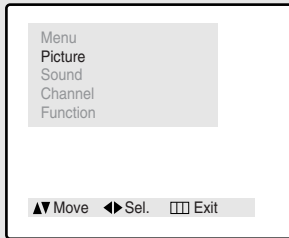

2

Press the **UP/DOWN** ▲▼ buttons to select "Size".

Press the **LEFT/RIGHT** ◀▶ buttons to select "Normal," "Zoom" or "16:9".

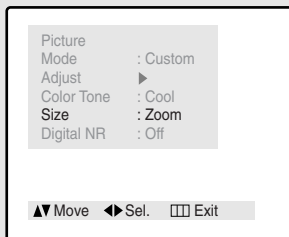

3

Press the **MENU** button to exit.

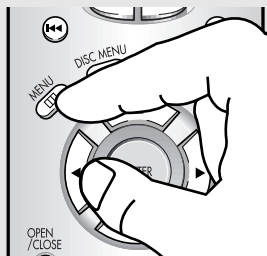

- Normal : Sets the picture to 4:3 normal mode. This is a standard TV screen size.
- Zoom : Sets the picture to Zoom mode.
- 16:9 : Sets the picture to 16:9 wide mode.

Changing the Color Tone

1

Press the **MENU** button to display the menu.

Press the **LEFT/RIGHT** ◀▶ buttons to display the Picture menu.

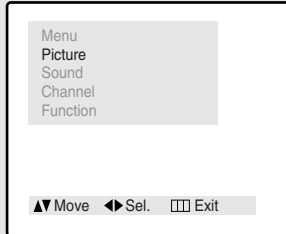

2

Press the **UP/DOWN** ▲▼ buttons to select Color Tone.

Press the **LEFT/RIGHT** ◀▶ buttons to select "Normal", "Warm" or "Cool" according to personal preference.

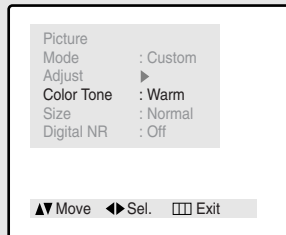

3

Press the **MENU** button to exit.

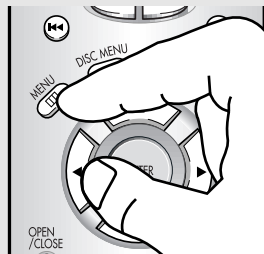

Setting the On/Off Timer

1

Press the **MENU** button to display the menu.

Press the **UP/DOWN** ▲▼ buttons to select **Function**. Press the **LEFT/RIGHT** ◀▶ buttons.

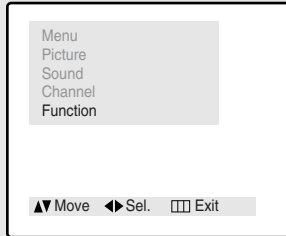

◀ Before using the timer, you must set the TV's clock. (See "Setting the Clock" on page 3.7)

2

Press the **LEFT/RIGHT** ◀▶ buttons to select the **Time**.



◀ V-Chip: USA only

3

Press the **UP/DOWN** ▲▼ buttons to select "On Time."

Press the **RIGHT** ▶ button to highlight the "On time" hours.

Press the **UP/DOWN** ▲▼ buttons repeatedly to select the appropriate hours (i.e., the hour when the TV will turn on.)

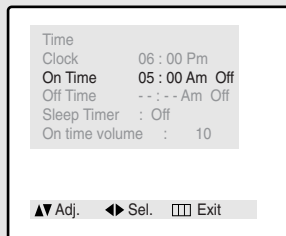

◀ When you set the hours, make sure the correct time of day (Am or Pm) appears to the right of the hour.

4

Press the **RIGHT** ▶ button to highlight the "On time" minutes.

Press the **UP/DOWN** ▲▼ buttons repeatedly to select the appropriate minutes.

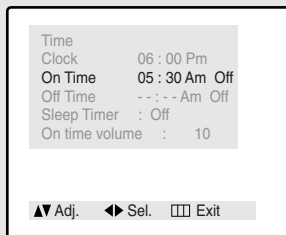

5

Press the **RIGHT ►** button to highlight "Off".

Press the **UP/DOWN▲▼** buttons to turn the on timer "On." (Repeatedly pressing the **UP/DOWN▲▼** buttons will alternate between On and Off.)

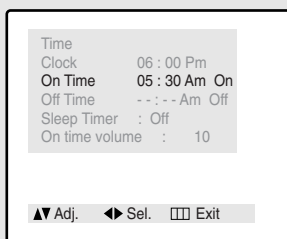

◀ To deactivate the "On time," select "Off" during this step.

6

When finished, press the **RIGHT ►** button.

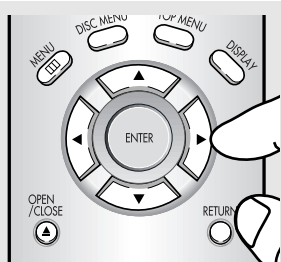

7

To set the Off time, press the **UP/DOWN▲▼** buttons to select "Off Time".

Press the **RIGHT ►** button and set the hours and minutes. (Follow the same procedure as in steps 1~6 above.)

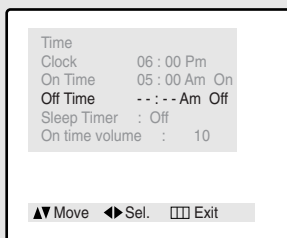

8

When finished setting the timer, press the **MENU** button to exit.

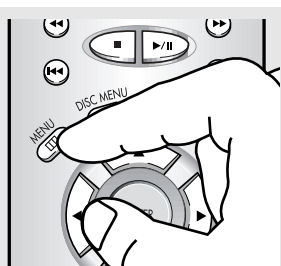

Setting the Sleep Timer

The sleep timer automatically shuts off the TV after a preset time (from 15 to 180 minutes).

1

Press the **MENU** button to display the menu.

Press the UP/DOWN▲▼ buttons to select Function.
Press the LEFT/RIGHT◀▶ buttons.

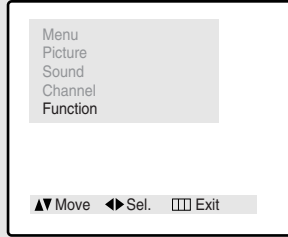

2

Press the LEFT/RIGHT◀▶ buttons to select the Time.

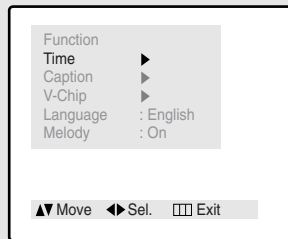

◀ V-Chip: USA only

3

Press the UP/DOWN▲▼ buttons to select "Sleep Timer."

Press the RIGHT▶ button repeatedly until the appropriate time interval appears (any of the preset values from "Off" to "180").

Press the **MENU** button to exit.

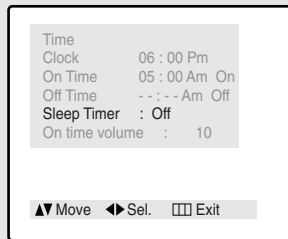

Alternate method:

Simply press **SLEEP** repeatedly until the appropriate time interval appears (any of the preset values from "Off" to "180").

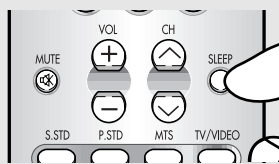

◀ After about 5 seconds, the sleep display will disappear from the screen, and the time interval will be set.

Sound Features

Choosing a Multi-Channel Sound (MTS) Soundtrack

Depending on the particular program being broadcast, you can listen to stereo, mono, or a Separate Audio Program. (SAP audio is usually a foreign-language translation. Sometimes SAP has unrelated information like news or weather.)

1

Press the **MENU** button to display the menu.

Press the UP/DOWN▲▼ buttons to select Sound.
Press the LEFT/RIGHT◀▶ buttons.

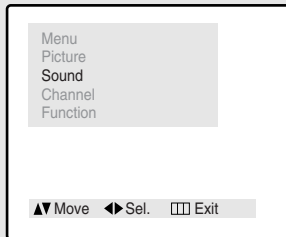

2

Press the UP/DOWN▲▼ buttons to select "MTS".

Press the LEFT/RIGHT◀▶ buttons repeatedly to select "Mono," "Stereo" or "SAP".

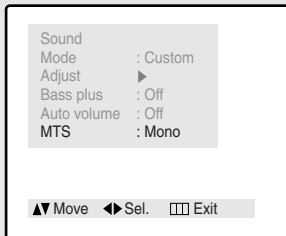

3

Press the **MENU** button to exit.

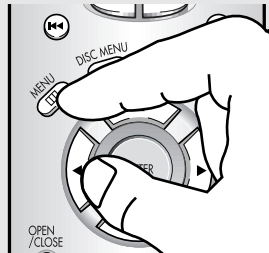

- Choose *Mono* for channels that are broadcasting in mono, or if you are having difficulty receiving a stereo signal.
- Choose *Stereo* for channels that are broadcasting in stereo.
- Choose *SAP* to listen to the Separate Audio Program, which is usually a foreign-language translation.

You can also change the MTS setting by pressing the "MTS" button on the remote control.

Auto Volume

Each broadcasting station has its own signal conditions, and it is not convenient adjust the volume every time the channel is changed. "Auto volume" lets you automatically adjust the volume of the desired channel by lowering the sound output when the modulation signal is high or by raising the sound output when the modulation signal is low.

1

Press the **MENU** button to display the menu.

Press the UP/DOWN▲▼ buttons to select Sound.
Press the LEFT/RIGHT◀▶ buttons.

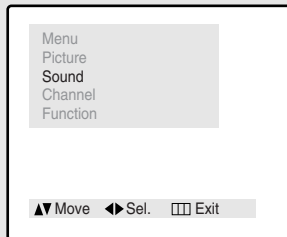

2

Press the UP/DOWN▲▼ buttons to select "Auto volume".

Press the LEFT/RIGHT◀▶ buttons to select "On".

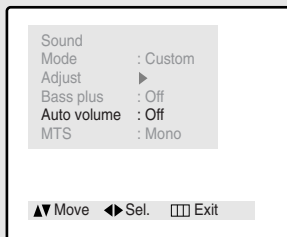

3

Press the **MENU** button to exit.

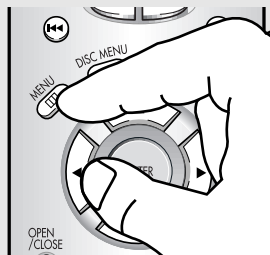

Bass Plus

Bass Plus emphasizes the bass frequencies to add fullness to the sound.

- 1**
 Press the **MENU** button to display the menu.
 Press the UP/DOWN▲▼ buttons to select Sound.
 Press the LEFT/RIGHT◀▶ buttons.

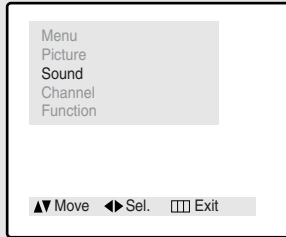

- 2**
 Press the UP/DOWN▲▼ buttons to select "Bass plus".
 Press the LEFT/RIGHT◀▶ buttons to select "On".

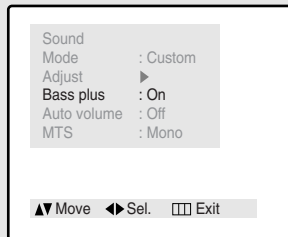

- 3**
 Press the **MENU** button to exit.

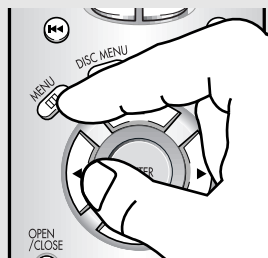

Setting the On/Off Melody

You can hear clear a melody sound when the TV is powered on or Off.

1

Press the **MENU** button to display the menu.

Press the UP/DOWN▲▼ buttons to select "Function".

Press the LEFT/RIGHT◀▶ buttons.



2

Press the UP/DOWN▲▼ buttons to select "Melody".

Press the LEFT/RIGHT◀▶ buttons to select "On" or "Off".

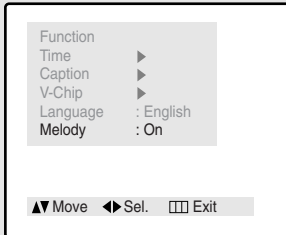

3

Press the **MENU** button to exit.

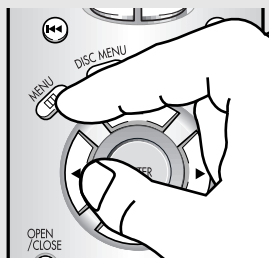

Viewing Closed Captions

Your TV decodes and displays the closed captions that are broadcast with certain TV shows. These captions are usually subtitles for the hearing impaired or foreign-language translations. All VCRs record the closed caption signal from television programs, so home-recorded video tapes also provide closed captions. Most DVDs and pre-recorded commercial video tapes provide closed captions as well. Check for the closed caption symbol in your television schedule and on the tape's packaging: .

1
Press the **MENU** button to display the menu.

Press the **UP/DOWN▲▼** buttons to select "Function".
Press the **LEFT/RIGHT◀▶** buttons.



2
Press the **UP/DOWN▲▼** buttons to select "Caption".
Press the **LEFT/RIGHT◀▶** buttons.

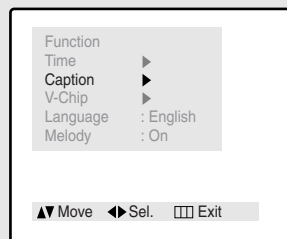

3
Press the **LEFT/RIGHT◀▶** buttons to turn closed captioning on/off.

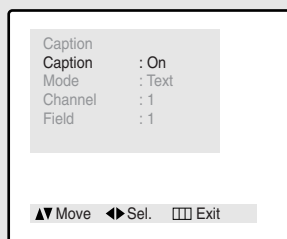

4
Press the **UP/DOWN▲▼** buttons to select "Mode".

Press the **LEFT/RIGHT◀▶** buttons to select "Caption" or "Text."

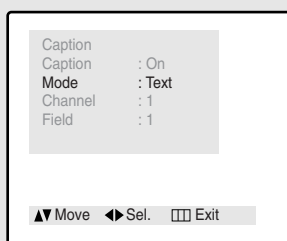

5
Depending on the particular broadcast, it might be necessary to make changes to "Channels" and "Field":
Use the **UP/DOWN▲▼**, **LEFT/RIGHT◀▶** buttons to make the changes. (Follow the same procedure as in steps 3-4 above.)
Press the **MENU** button to exit.

◀ V-Chip: USA only

◀ Misspellings and unusual characters sometimes occur during closed caption transmissions, especially those of live events. There may be a small delay before captions appear when you change channels. These are not malfunctions of the TV.

◀ In **caption mode**, captions appear at the bottom of the screen, and they usually cover only a small portion of the picture.

In **text mode**, information unrelated to the program, such as news or weather, is displayed. Text often covers a large portion of the screen.

◀ Different channels and fields display different information: Field 2 carries additional information that supplements the information in Field 1. (For example, Channel 1 may have subtitles in English, while Channel 2 has subtitles in Spanish.)

Using the V-Chip (USA only)

The V-Chip feature automatically locks out programming that is deemed inappropriate for children. The user must first enter a PIN (personal ID number) before any of the V-Chip restrictions can be set up or changed.

Setting Up Your Personal ID Number (PIN)

1

Press the **MENU** button to display the menu.

Press the UP/DOWN▲▼ buttons to select "Function". Press the LEFT/RIGHT ◀▶ buttons.

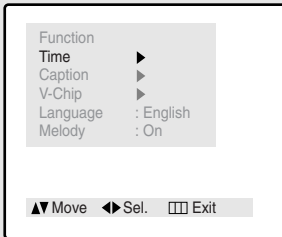

2

Press the UP/DOWN▲▼ buttons to select "V-Chip". Press the LEFT/RIGHT ◀▶ buttons.

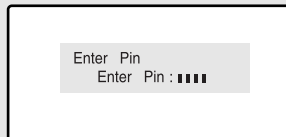

The "Enter pin" screen will appear. Enter your 4-digit PIN number. Note: The default PIN number for a new TV set is "0-0-0-0."

3

After entering a valid PIN number, the "V-chip mode" screen will appear. Press the UP/DOWN▲▼ buttons to select "Change pin".

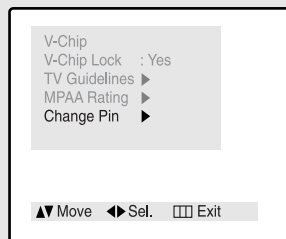

4

While the "Change pin" field is selected, press the LEFT/RIGHT ◀▶ buttons. The Change pin screen will appear. Choose any 4-digits for your PIN and enter them.

As soon as the 4 digits are entered, the "Confirm pin" screen appears. Re-enter the same 4 digits. When the Confirm screen disappears, your PIN has been memorized. Press the **MENU** button to exit.

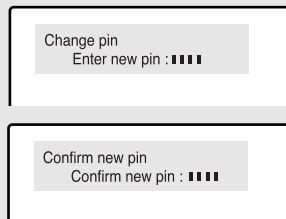

◀ Note: If you forget the PIN, press the remote-control buttons in the following sequence, which resets the pin to 0-0-0-0:

POWER OFF → MUTE → 8 → 2 → 4 → POWER ON.

How to Enable/Disable the V-Chip

1

Press the **MENU** button to display the menu.

Press the UP/DOWN▲▼ buttons to select "Function".

Press the LEFT/RIGHT◀▶ buttons.

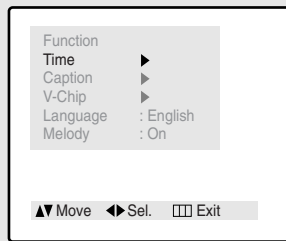

2

Press the UP/DOWN▲▼ buttons to select "V-Chip". Press the LEFT/RIGHT◀▶ buttons.

The "Enter pin" screen will appear. Enter your 4-digit PIN number.

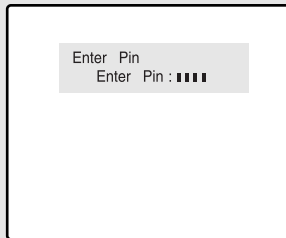

3

After entering a valid PIN number, the "V-chip mode" screen will appear. To enable the V-Chip feature, press the LEFT/RIGHT◀▶ buttons so that the "V-Chip lock" field is Yes. (Pressing the LEFT/RIGHT◀▶ buttons will alternate between Yes and No.)

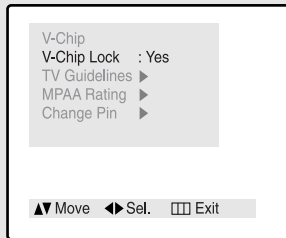

How to Set up Restrictions Using the "TV guidelines"

First, set up a personal identification number (PIN), and enable the V-Chip. (See previous section.) Parental restrictions can be set up using either of two methods: The TV guidelines or the MPA rating.

1

Press the **MENU** button to display the menu.

Press the UP/DOWN▲▼ buttons to select "Function".

Press the LEFT/RIGHT◀▶ buttons.

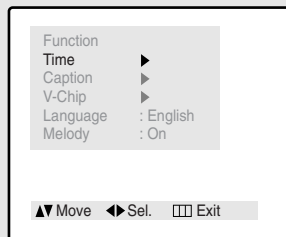

2

Press the UP/DOWN▲▼ buttons to select "V-Chip". Press the LEFT/RIGHT◀▶ buttons.

The "Enter pin" screen will appear. Enter your 4-digit PIN number.

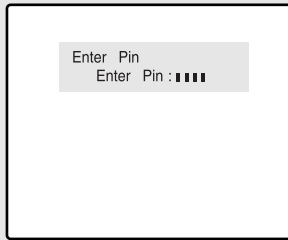

3

The "V-chip mode" screen will appear. Press the UP/DOWN▲▼ buttons to select "TV Guidelines".

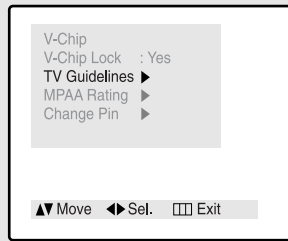

4

Press the LEFT/RIGHT◀▶ buttons. The "TV guidelines" screen will appear. Press the UP/DOWN▲▼ buttons to select one of the six age-based categories:

TV-Y Young children
TV-Y7 Children 7 and over

TV-G General audience
TV-PG Parental guidance
TV-14 Viewers 14 and over
TV-MA Mature audience

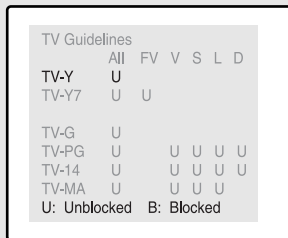

◀ Note: These categories consist of two separate groups: TV-Y and TV-Y7 (young children through age 7), and TV-G through TV-MA (everybody else).

The restrictions for these two groups work independently: If a household includes very young children as well as young adults, the TV guidelines must be set up separately for each age group. (See next step.)

5

At this point, one of the TV-Ratings is selected.

Press the LEFT/RIGHT◀▶ buttons: Depending on your existing setup, a letter "U" or "B" will be selected. (U= Unblocked, B= Blocked)

While the "U" or "B" is selected, press the UP/DOWN▲▼ buttons to block or unblock the category. Press the LEFT/RIGHT◀▶ buttons to save the TV guidelines. A TV-Rating will be selected. To select a different TV-Rating, press the UP/DOWN▲▼ buttons and then repeat the process.

Note 1: The TV-Y7, TV-PG, TV-14 and TV-MA have additional options. See the next step to change any of the following sub-ratings:

FV: Fantasy violence
D: Sexual suggestive dialog
L: Adult language
S: Sexual situation
V: Violence

Note 2: The V-Chip will automatically block certain categories that are "more restrictive." For example, if you block "TV-Y" category, then TV-Y7 will automatically be blocked. Similarly, if you block the TV-G category, then all the categories in the "young adult" group will be blocked (TV-G, TV-PG, TV-14 and TV-MA). The sub-ratings (D, L, S, V) work together similarly. (See next section.)

6**How to set the FV, D, L, S and V sub-ratings.**

First, select one of these TV-Ratings: TV-Y7, TV-PG, TV-14 or TV-MA (See Step 4, on previous page). Next, while the TV-Rating is selected, repeatedly press the LEFT/RIGHT ◀▶ buttons. This will cycle through the available sub-ratings (FV, L, S, D or V).

A letter ("U" or "B") will be displayed for each sub-rating. While the "U" or "B" is selected, press the UP/DOWN ▲▼ buttons to change the sub-rating. Press the LEFT/RIGHT ◀▶ buttons to save the TV guidelines. A TV-Rating will be selected. To select a different TV-Rating, press the UP/DOWN ▲▼ buttons and then repeat the process.

Note: The V-chip will automatically block certain categories that are "More restrictive". For example, if you block "L" sub-rating in TV-PG, then the "L" sub-ratings in TV-14 and TV-MA will automatically be blocked.

7

Press the **MENU** button to clear all the screens. (Or proceed to the next section, and set up additional restrictions based on the MPAA codes).

How to Set up Restrictions using the MPAA Ratings: G, PG, PG-13, R, NC-17, X

The MPAA rating system uses the Motion Picture Association of America (MPAA) system, and its main application is for movies. (Eventually, movie videocassettes and DVDs will be encoded with MPAA ratings.) When the V-Chip lock is on, the TV will automatically block any programs that are coded with objectionable ratings (either MPAA or TV-Ratings).

1

Press the **MENU** button to display the menu.

Press the UP/DOWN ▲▼ buttons to select "Function".
Press the LEFT/RIGHT ◀▶ buttons.

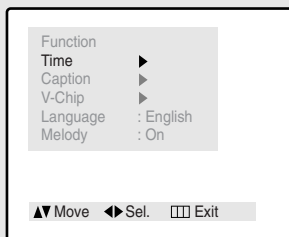
**2**

Press the UP/DOWN ▲▼ buttons to select "V-Chip".
Press the LEFT/RIGHT ◀▶ buttons.

The "Enter pin" screen will appear. Enter your 4-digit PIN number.

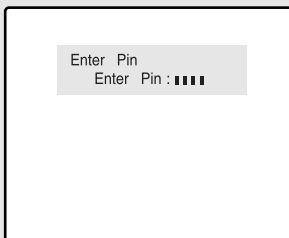

3
The “V-chip mode” screen will appear. Press the UP/DOWN▲▼ buttons to select the “MPAA Rating.”

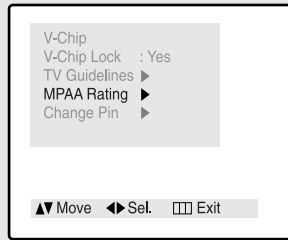

4
While “MPAA rating” is selected, press the LEFT/RIGHT◀▶ buttons. The “MPAA Rating” screen will appear.

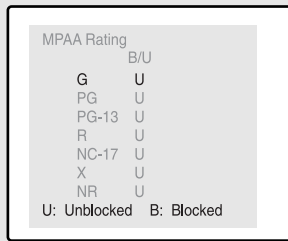

5
Repeatedly press the UP/DOWN▲▼ buttons to select a particular MPAA category. Pressing the UP/DOWN▲▼ buttons will cycle through the MPAA categories:

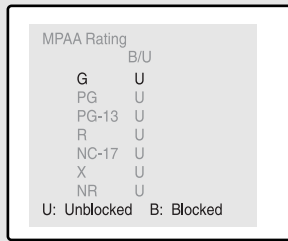

- G** General audience (no restrictions).
- PG** Parental guidance suggested.
- PG-13** PG-13 (Parents strongly cautioned).
- R** R (Restricted. Children under 17 should be accompanied by an adult).
- NC-17** No children under age 17.
- X** X (Adults only).
- NR** Not rated.

While a particular category is selected, press the LEFT/RIGHT◀▶ buttons to activate it. A letter (“U” or “B”) will be selected. Press the UP/DOWN ▲▼ buttons to select “U” or ”B”. Press the LEFT/RIGHT◀▶ buttons to save the settings and Press the MENU button to exit. Note: The V-Chip will automatically block any category that is “more restrictive.” For example, if you block the “PG-13” category, then “R,” “NC-17,” and “X” will automatically be blocked also.

How to Reset the TV after the V-Chip Blocks a Channel (“Emergency Escape”)

If the TV is tuned to a restricted channel, the V-Chip will block it. The screen will go blank and the following message will appear: “Excessive rating.”

To resume normal viewing, tune to a different channel using the number buttons. Under certain conditions (depending on the rating of the local TV programs) the V-Chip might lock out all the channels. In this case, use the V.Chip button for an “emergency escape”:

1. Press the MENU button on the remote control.
2. Press the UP/DOWN▲▼ buttons to select the “Function”, then press the LEFT/RIGHT◀▶ buttons.
3. Press the UP/DOWN▲▼ buttons to select the “V-Chip”, then press the LEFT/RIGHT◀▶ buttons.
4. Enter your PIN number, and press the LEFT/RIGHT◀▶ buttons to temporarily disable the V-Chip Lock.

Chapter Five

DVD OPERATION

Playing a Disc

Playback

1

Press the **OPEN/CLOSE** button.

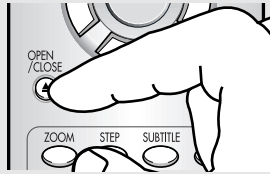

2

Place a disc gently into the tray with the disc's label facing up



3

Press the **PLAY/PAUSE (▶/||)** or **OPEN/CLOSE** button to close the disc tray.

◀ RESUME function

When you stop disc play, the player remembers where you stopped, so when you press the **PLAY** again, it will pick up where you left off (unless the disc is removed, the **STOP (■)** button is pressed twice or the set is unplugged).

If the player is left for 5 minutes in pause mode, it will stop.

This  icon indicates an invalid button press.

Stopping Playback

Press the **STOP (■)** button during playback.

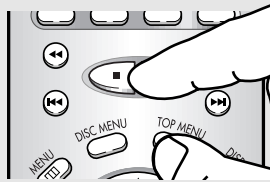

Removing Disc

Press the **OPEN/CLOSE** button.

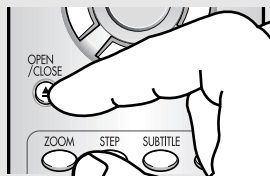

Pausing Playback

Press the **PLAY/PAUSE (▶/||)** or **STEP** button on the remote control during playback.

- Screen stops, no sound.
- To resume again, press the **PLAY/PAUSE (▶/||)** button once again.

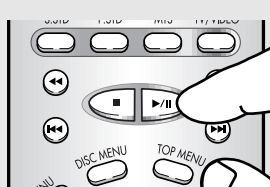

Step Motion Playback (Except CD)

Press the **STEP** button on the remote control during playback.

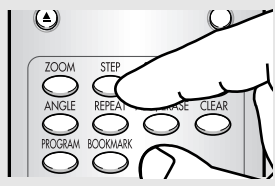

- Each time the button is pressed, a new frame will appear.
- No sound is heard during STEP mode.
- Press the PLAY/PAUSE(▶/||) button to resume normal playback (You can only perform step motion playback in the forward direction).

Slow Motion Playback (Except CD)

Press the **FWD(▶▶)** SEARCH button on the remote control during PAUSE or STEP mode.

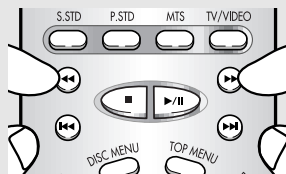

- By pressing the FWD SEARCH button, you can select slow motion playback for 1/8, 1/4 or 1/2 of normal speed.
- No sound is heard during slow mode.
- Press the PLAY/PAUSE(▶/||) button to resume normal playback.
- When playing a VCD, the reverse slow motion play will not work.

Using the Search and Skip Functions

Searching through a Chapter or Track

Press the **FWD**(▶▶) or **REW**(◀◀) **SEARCH** button on the remote control during playback.

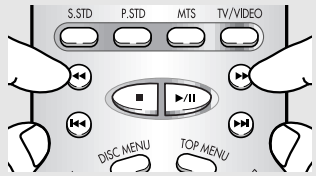

◀ When in search mode (2X/4X/8X/16X/32X/128X) on a DVD or high-speed playback on a VCD, no sound will be heard.

- Press the **FWD**(▶▶) or **REW**(◀◀) **SEARCH** button on the remote control and press again to search at a faster speed (2X/4X/8X/16X/32X/128X) on the DVD.
- Press the **FWD**(▶▶) or **REW**(◀◀) **SEARCH** button on the remote control and press again to search at a faster speed on VCD (4X/8X) and CD (2X/4X/8X).
- To return to normal speed playback, press the **PLAY/PAUSE**(▶/||) button.

Skipping Tracks

During playback, press the **NEXT SKIP**(▶▶|) or **BACK SKIP**(|◀◀) button.

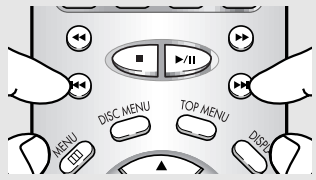

- When playing a DVD, if you press the **NEXT SKIP**(▶▶|) button, it moves to next chapter. If you press the **BACK SKIP**(|◀◀) button, it moves to the beginning of the chapter. One more press makes it move to the beginning of the previous chapter.
- When playing a VCD 2.0 in MENU OFF mode, a VCD1.1 or a CD, if you press the **NEXT SKIP**(▶▶|) button, it moves to next track. If you press the **BACK SKIP**(|◀◀) button, it moves to the beginning of the track. One more press makes it move to the beginning of the previous track.
- If a track exceeds 15 minutes when playing a VCD and you press the **NEXT SKIP**(▶▶|) button, it moves forward 5 minutes. If you press the **BACK SKIP**(|◀◀) button, it moves backward 5 minutes.
- When playing a VCD 2.0 in the MENU MODE or Track View function, if you press the **NEXT SKIP**(▶▶|) button, it moves to the next MENU or the next Track View display. If you press the **BACK SKIP**(|◀◀) button, it moves to the previous MENU or the previous Track View display.

Using the Display Function

When Playing a DVD

1

During playback, press the **DISPLAY** button.

Current title, chapter number and elapsed time will be displayed.



2

Press the UP/DOWN▲▼ buttons to select a title or a chapter number. Press the LEFT/RIGHT◀▶ buttons or Number buttons to enter a different title or chapter number, then press the **ENTER** button.

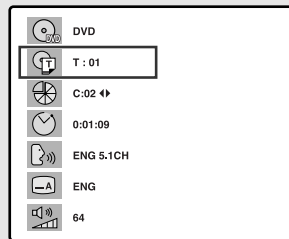

3

To enter the time from which you want to start, press the UP/DOWN▲▼ buttons to select, then press the Number buttons to enter the time. Then press the **ENTER** button.

Press the UP/DOWN▲▼ buttons to change the values of the current audio, subtitle and volume.

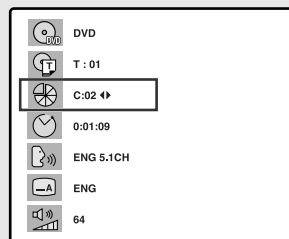

4

To make the screen disappear, press the **DISPLAY** button again.



- What is a Chapter?
Each Title on a DVD can be divided into chapters (similar to tracks on an audio CD).
- What is a Title?
A DVD may contain several different titles. For example, if a disc contains four different movies, each might be considered a title.

When Playing a CD/VCD

1

During playback, press the **DISPLAY** button.

Current track number, elapsed time and volume control will be displayed.



2

Press the UP/DOWN▲▼ buttons to select a track. Press the LEFT/RIGHT◀▶ buttons or Number buttons to enter a different track number, then press the **ENTER** button.

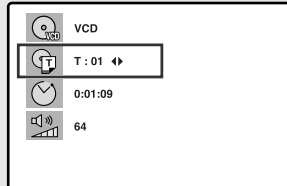

< VCD >

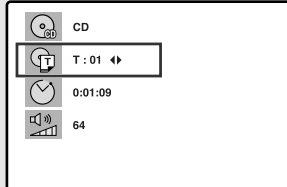

< CD >

3

To enter the time from which you want to start, press the UP/DOWN▲▼ buttons to select, then press the Number buttons to enter the time. Press the **ENTER** button.

To change the value of the volume, use the LEFT/RIGHT◀▶ buttons.

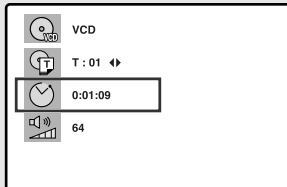

< VCD >



< CD >

4

To make the screen disappear, press the **DISPLAY** button again.

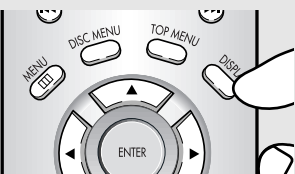

Repeat Play

Repeat the current track, chapter, title, a chosen section (A-B), or all of the disc.

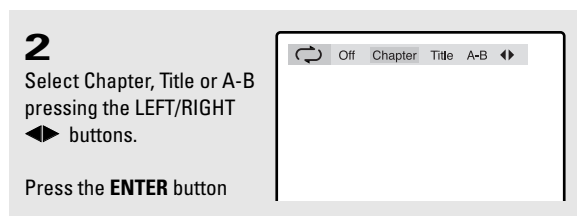
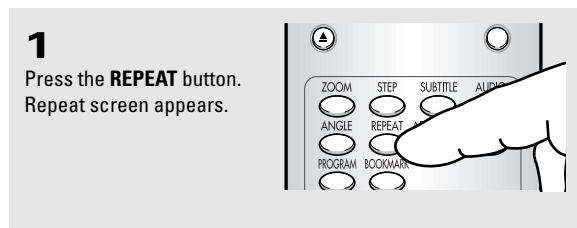

A-B Repeat

- ❶ Press the **REPEAT** button. Select A-B on screen with the LEFT/RIGHT ◀▶ buttons.
- ❷ Press the **ENTER** button at the point where you want the repeat play to start (A).
The B is automatically highlighted.
- ❸ Press the **ENTER** button at the point where you want the repeat play to stop (B).
- ❹ The A-B Repeat that you set plays until you turn Repeat off.

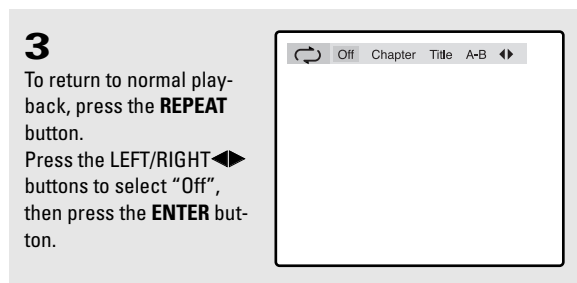

Note

- DVD repeats playback by chapter or title, CD and VCD repeat playback by disc or track.
- Depending on the disc, the Repeat function may not work.
- If the title or track is completed before marking the end (B), the end of title or track becomes B automatically.
- When in VCD 2.0 mode (Menu On mode), this function does not work.

Program Play and Random Play

Program Playback

- 1**
Press the **PROGRAM** button.

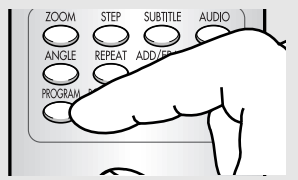

- 2**
Press the LEFT/RIGHT ◀▶ buttons to select "PROGRAM".
Press the **ENTER** button.

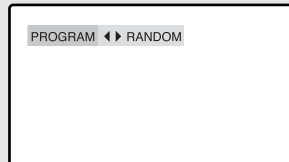

- 3**
Press the LEFT/RIGHT ◀▶ buttons to select the first chapter (or track) to add to the program.
Press the **ENTER** button.
The selection numbers appear in the Program Order box.

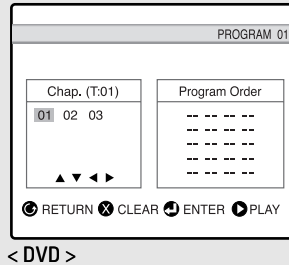

- 4**
Press the **PLAY/PAUSE** (▶/||) button.
The disc will be played back in programmed order.

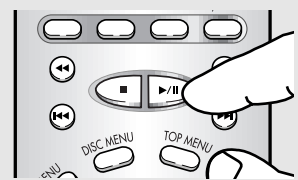

◀ Depending on the disc, the Program and Random Playback function may not work.
When in VCD 2.0 mode (Menu On mode), these functions do not work.
To resume normal playback, press the CLEAR button.

Random Playback

- 1**
Press the **PROGRAM** button.

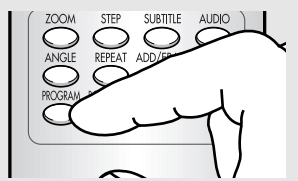

- 2**
Press the LEFT/RIGHT ◀▶ buttons to select "RANDOM".
Press the **ENTER** button.

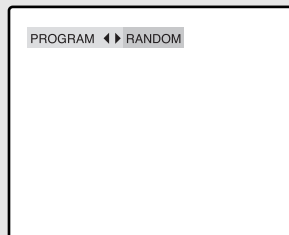

The disc will be played back in random order.

Using the Disc View Function (VCD)

Track View/Index View

Displays the beginning view of each track and the track number (Track View).

Displays the equally divided 9 views of the current playing track (Index View).

- 1**
During playback, press the **TOP MENU** button.



- 2**
Press the UP/DOWN▲▼ buttons to select "Track View" or "Index View". Press the **ENTER** button.

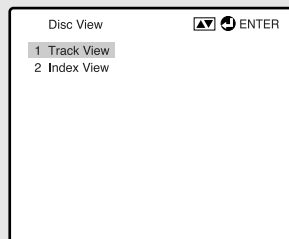

- 3**
Select the desired view by pressing the UP/DOWN▲▼ or LEFT/RIGHT◀▶ buttons. Press the **ENTER** button.

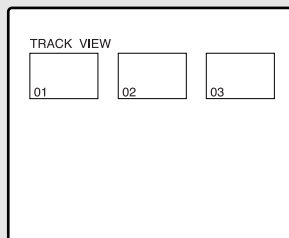

< Track View >

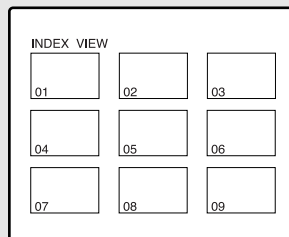

< Index View >

◀ When pressing the TOP MENU button with a DVD; the disc's TITLE MENU function comes up. A disc must have at least two titles for the TITLE MENU function to work.

When pressing the TOP MENU button with a CD; the unit enters the INTRO mode. INTRO lets you listen to the beginning of each track for about 10 seconds.

Selecting the Audio Language

Using the AUDIO Button

You can select a desired language quickly and easily with the AUDIO button.

- 1**
Press the **AUDIO** button.

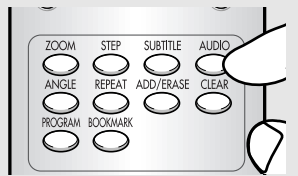

- 2**
Press the UP/DOWN▲▼ buttons to select the desired language on a DVD.

The audio languages are represented by abbreviations.

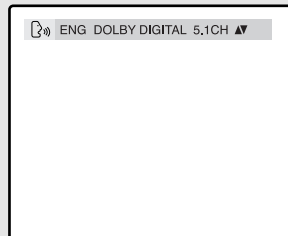

- 3**
Press the UP/DOWN▲▼ buttons to select Stereo, Right or Left (On VCD/CD).



◀ This function depends on what languages are encoded on the disc and may not work with all DVDs.

A DVD disc can contain up to 8 audio languages.

How to have the same audio language come up whenever you play back a DVD:

Refer to “Using the DVD SETUP Button (When in the DVD mode)” on page 5.10.

Using the MENU Button (When in the DVD mode)

1
Press the **MENU** button.



2
Press the UP/DOWN▲▼ buttons to select “DVD Setup”.
Press the LEFT/RIGHT ◀▶ buttons.
The **SETUP MENU** is displayed.

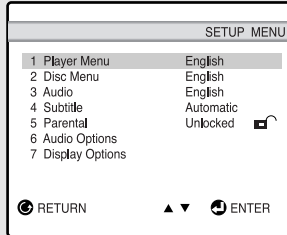

3
Press the UP/DOWN▲▼ buttons to select “Audio”.
Press the **ENTER** button.

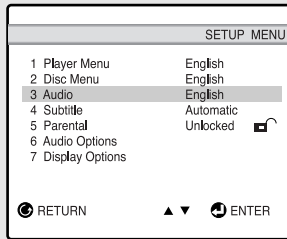

4
Press the UP/DOWN▲▼ buttons to select appropriate language, then press the **ENTER** button.

Press the **RETURN** button to exit.

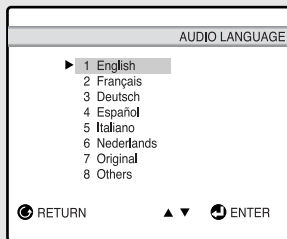

◀ Select “Original” if you want the default soundtrack language to be the original language the disc is recorded in.

If the selected language is not recorded on the disc, the original pre-recorded language is selected.

Selecting the Subtitle Language

Using the SUBTITLE button

You can select a desired subtitle quickly and easily with the SUBTITLE button.

1
Press the **SUBTITLE** button.

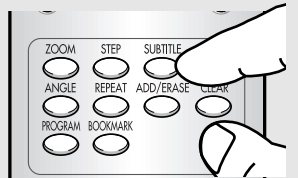

2
Press the UP/DOWN▲▼ buttons to select the desired subtitle language.

The subtitle languages are represented by abbreviations.

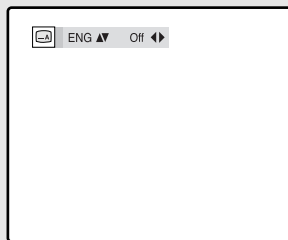

3
Press the LEFT/RIGHT ◀▶ buttons to determine whether or not the subtitle will be displayed.

Initially, the subtitling will not appear on screen. The subtitle languages are represented by abbreviations.

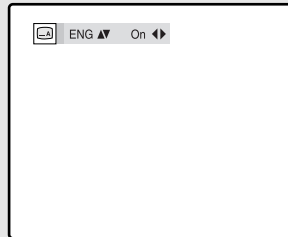

◀ This function depends on what languages are encoded on the disc and may not work with all DVDs.

A DVD disc can contain up to 32 subtitle languages.

How to have the same subtitle language come up whenever you play back a DVD:

Refer to “Using the MENU Button (When playing a DVD)” on page 5.12.

Using the MENU Button (When in the DVD mode)

- 1**
Press the **MENU** button.

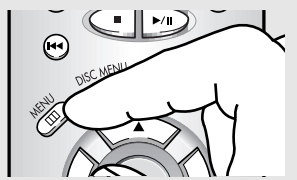

- 2**
Press the UP/DOWN▲▼ buttons to select "DVD Setup".
Press the LEFT/RIGHT◀▶ buttons.
The **SETUP MENU** is displayed.

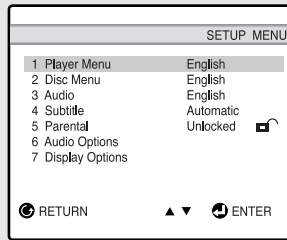

- 3**
Press the UP/DOWN▲▼ buttons to select "Subtitle".
Press the **ENTER** button.

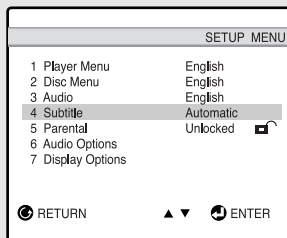

- 4**
Press the UP/DOWN▲▼ buttons to select the appropriate language, then press the **ENTER** button.

Press the **RETURN** button to exit.

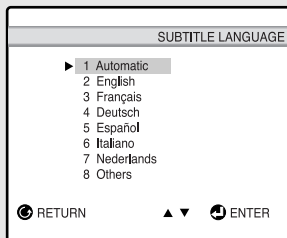

◀ Select "Automatic" if you want the subtitle language to be the same as the language selected as the audio preference.

If the selected language is not recorded on the disc, the original pre-recorded language is selected.

Using the Master Volume Control Function

Press the **DISPLAY** button once or twice, then press the LEFT/RIGHT◀▶ buttons to select master volume control.

Press the UP/DOWN▲▼ buttons to select a suitable volume.



- Master Volume Control function lets you adjust the volume of the player's output. This is useful for matching the player's output level to other equipment in your system.
- Volume control is only operative when using the Analog Audio outputs.
- There are up to 64 levels. Lowering each level reduces the audio level by 0.5dB.

Changing the Camera Angle

When a DVD contains multiple angles of a particular scene, you can select the Angle function.

Using the ANGLE button

Press the ANGLE button to see if an ANGLE () mark is present at the upper right hand corner of the screen.

1

When an ANGLE mark is shown, press the **ANGLE** button, then an ANGLE select icon will appear at the upper left hand corner of the screen.

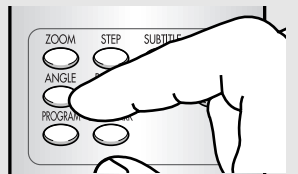

2

Press the UP/DOWN▲▼ buttons to select the desired screen angle, then press the **ENTER** button.

To turn off the display, press the **ANGLE** button again.

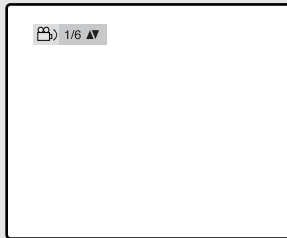

Using the Zoom Function (DVD/VCD)

1

During playback or pause mode, press the **ZOOM** button on the remote. A square will be displayed on screen.

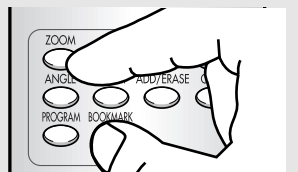

2

Press the UP/DOWN▲▼ or LEFT/RIGHT◀▶ buttons to select the part of the screen you want to zoom.

Press the **ENTER** button.

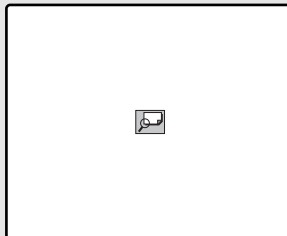

- During DVD playback, press the ENTER button to zoom in 2X/4X/2X in order.
- During VCD playback, press the ENTER button to zoom in 2X.

Using the Bookmark Function

The Bookmark function lets you select parts of a DVD or VCD (MENU OFF mode) so that you can quickly find the section at a later time.

Using the Bookmark Function (DVD/VCD)

- 1**
During playback, press the **BOOKMARK** button.
A marker will be displayed.

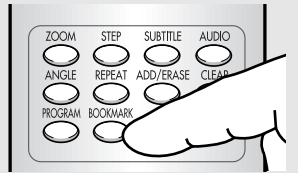

- 2**
Press the LEFT/RIGHT ◀▶ buttons to move to the desired bookmark icon.



- 3**
When you reach the scene you want to mark, press the **ENTER** button.
The icon will change to a number (1, 2, or 3).

Press the **BOOKMARK** button to turn off the display.

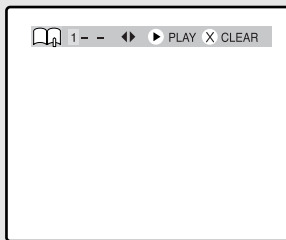

Recalling a Marked Scene

- 1**
During playback, press the **BOOKMARK** button.
A marker will be displayed.

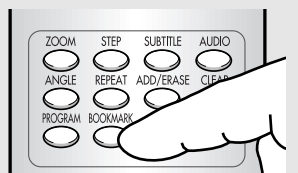

- 2**
Press the LEFT/RIGHT ◀▶ buttons to select a marked scene.



- 3**
Press the **PLAY/PAUSE** (▶/||) button to skip to the marked scene.

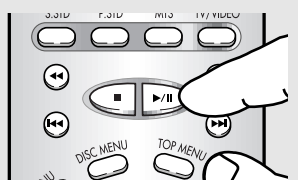

Clearing a Bookmark

1

During playback, press the **BOOKMARK** button.
A marker will be displayed.

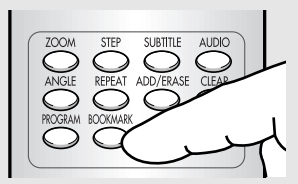

2

Press the LEFT/RIGHT ◀▶ buttons to select the bookmark number you want to delete.

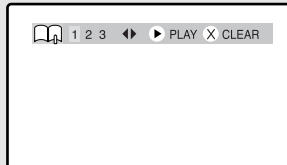

3

Press the **CLEAR** button to delete a bookmark number.
Press the **BOOKMARK** button to turn off display.

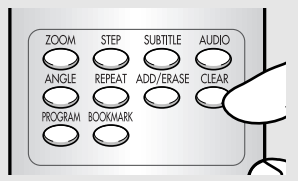

- Up to three scenes may be marked at the same time.
- When in VCD 2.0 mode (Menu On mode), this function does not work.
- Depending on the disc, the Bookmark function may not work.

MP3 Play

When an MP3 Disc is inserted into the DVD player, the first song file of the first folder plays.

MP3 Play Function

1

Press **STOP** to stop playback of the first song file, then press **RETURN** to display the music folder menu on the right side of the screen. Up to 8 music folders can be displayed at a time. If you have more than 8 folders on a disc, press the **LEFT/RIGHT** **◀▶** buttons to bring them up on the screen.

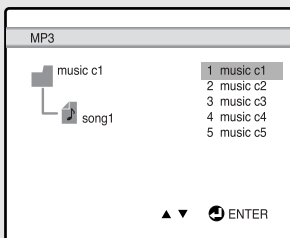

2

Press the **UP/DOWN** **▲▼** buttons to select the desired music folder, then press **ENTER**. Press the **UP/DOWN** **▲▼** buttons again to select a song file. Press **ENTER** to begin playback of the song file.

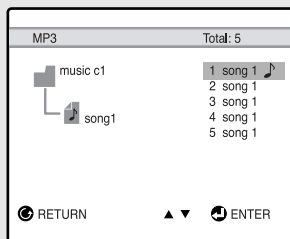

Program/Random playback

1

Press the **PROGRAM** button to switch between the **RANDOM** and **PROGRAM** modes. See page 4.7 for more information on these modes.

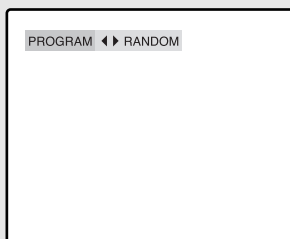

Notes:

- A musical note is displayed next to the file currently playing.
- Press the **REPEAT** button to hear only music continuously and press it once again to release.

CD-R MP3 discs

In the case of CD-R MP3 discs, please follow all the recommendations for CD-R above, plus the comments below:

- **Your MP3 files should be ISO 9660 or JOLIET format.**

ISO 9660 format and Joliet MP3 files are compatible with Microsoft's DOS and Windows, and with Apple's Mac. These two formats are the most widely used.

- **When naming your MP3 files do not exceed 8 characters, and place ".mp3" as the file extension.**

General name format of: Title.mp3. When composing your title, make sure that you use 8 characters or less, have no spaces in the name, and avoid the use of special characters including: (.,/, \, =, +).

- **Use a decompression transfer rate of at least 128 kb/sec (kilobytes/second) when recording MP3 files.**

Sound quality with MP3 files basically depends on the rate of compression/decompression you choose. Getting audio CD quality sound requires an analog/digital sampling rate, that is conversion to MP3 format, of at least 128 kb/sec and up to 160 kb/sec. However, choosing higher rates, like 192 kb/sec or more, only rarely give better sound quality. Conversely, files with sampling rates below 128 kb/sec will not be played properly.

- **Do not try recording copyright protected MP3 files.**

Certain "securized" files are encrypted and code protected to prevent illegal copying. These files are of the following types: Windows Media™ (registered trade mark of Microsoft Inc) and SDMI™ (registered trade mark of The SDMI Foundation). You cannot copy such files.

- **Your DVD player only accepts one level of file directory.**

Consequently you must choose:

- either to save all your MP3 recording files at the root of the disc;
- and/or create folders in the directory for each artist or music type (e.g.classical, rock, jazz, etc)

- **Important:**

The above recommendations cannot be taken as a guarantee that the DVD player will play MP3 recordings, or as an assurance of sound quality. You should note that certain technologies and methods for MP3 file recording on CD-Rs prevent optimal playback of these files on your DVD player (degraded sound quality and in some cases, inability of the player to read the files).

Setting up the Language Features

If you set the player menu, disc menu, audio and subtitle language in advance, it will come up automatically every time you watch a movie.

Using the Player Menu

Use the Player preference menu to select the language for the player's on-screen displays.

- 1**
Press the **MENU** button.

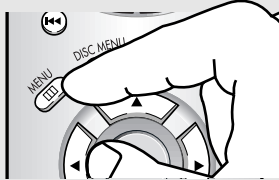

- 2**
Press the UP/DOWN▲▼ buttons to select "DVD Setup".
Press the LEFT/RIGHT◀▶ buttons.
The **SETUP MENU** is displayed.

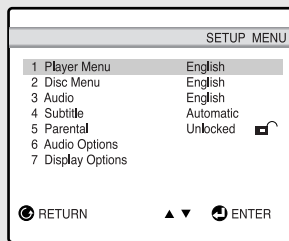

- 3**
Press the UP/DOWN▲▼ buttons to select "Player Menu", then press the **ENTER** button.

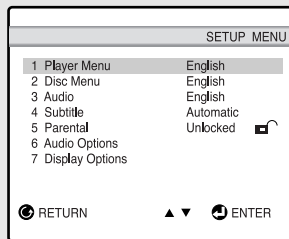

- 4**
Press the UP/DOWN▲▼ buttons to select the appropriate language, then press the **ENTER** button.

Press the **RETURN** button to exit.

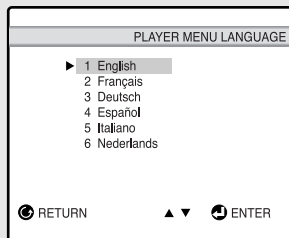

Using the Disc Menu Language

Use the Menu preference menu to select the language you want a DVD's disc menu to be displayed in.

- 1**
Press the **MENU** button.



- 2**
Press the UP/DOWN▲▼ buttons to select "DVD Setup".
Press the LEFT/RIGHT ◀▶ buttons.
The **SETUP MENU** is displayed.

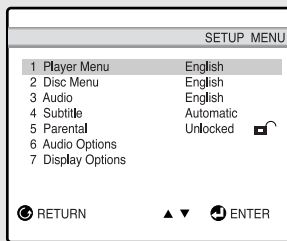

- 3**
Press the UP/DOWN▲▼ buttons to select "Disc Menu", then press the **ENTER** button.

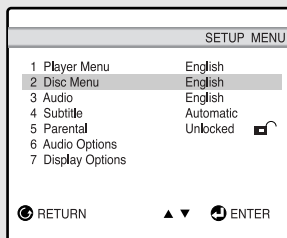

- 4**
Press the UP/DOWN▲▼ buttons to select the appropriate language, then press the **ENTER** button.

Press the **RETURN** button to exit.

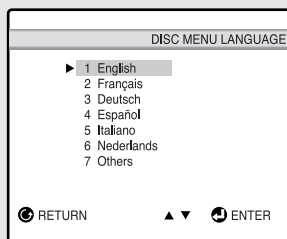

◀ If the selected language is not recorded on the disc, the original pre-recorded language is selected.

Setting up the Parental Control

The Parental Control function works in conjunction with DVDs that have been assigned a rating - which helps you control the types of DVDs that your family watches. There are up to 8 rating levels on a disc.

- 1**
Press the **MENU** button.



- 2**
Press the UP/DOWN▲▼ buttons to select "DVDP Setup".
Press the LEFT/RIGHT◀▶ buttons.
The SETUP MENU is displayed.

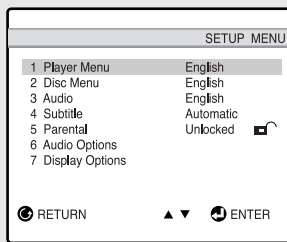

- 3**
Press the UP/DOWN▲▼ buttons to select "Parental", then press the **ENTER** button.

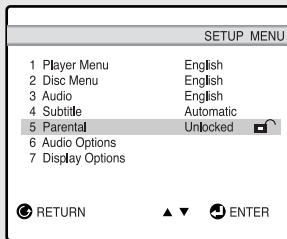

- 4**
Press the LEFT/RIGHT◀▶ buttons to select "Yes" if you want to use a password, then press the **ENTER** button.
The Enter Password screen appears.

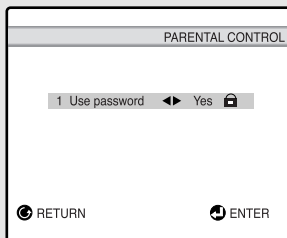

- 5**
Enter your password.
The Re-enter Password screen appears to confirm the password.
Enter your password again.
The Parental Control screen appears.

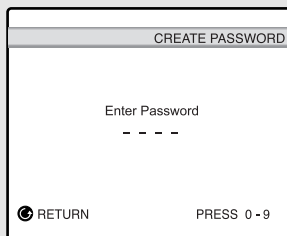

6

About the Rating Level;
The Rating Level will work only when use password is set to "Yes". To unlock the player, press LEFT/RIGHT ◀▶ buttons to select "No".

- ① Press the UP/DOWN ▲▼ buttons to select the "Rating Level", then press the **ENTER** button.
- ② Press the UP/DOWN ▲▼ buttons to select the Level(e.g. Level 8), then press the **ENTER** button. Disc that contain Level 7 will now not play.

To cancel the rating level, press the LEFT/RIGHT ◀▶ buttons to select No in Use Password.

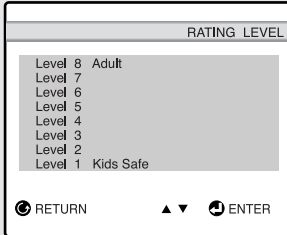
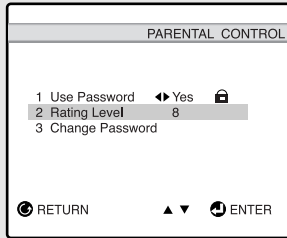

7

About Change Password;

- ① Press the UP/DOWN ▲▼ buttons to select "Change Password". The Change Password screen appears.
- ② Enter your new password. Re-enter the new password again.

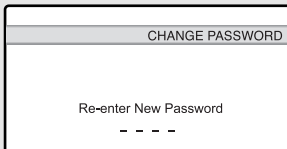
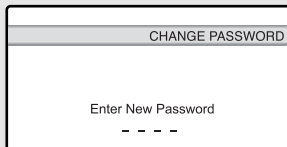
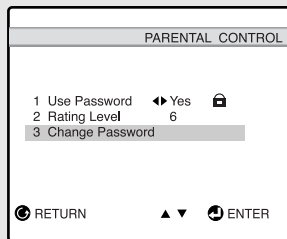

8

Press the **RETURN** button to exit.



Setting up the Audio Options

- 1**
Press the **MENU** button.

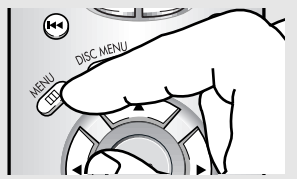

- 2**
Press the UP/DOWN▲▼ buttons to select "DVD Setup".
Press the LEFT/RIGHT ◀▶ buttons.
The **SETUP MENU** is displayed.

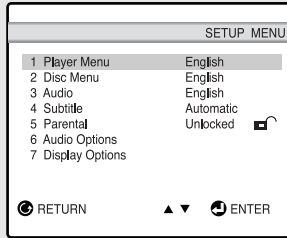

- 3**
Press the UP/DOWN▲▼ buttons to select "Audio Options", then press the **ENTER** button.

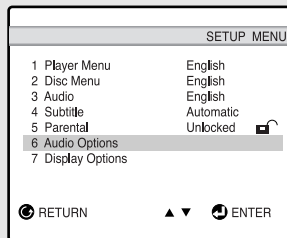

- 4**
Press the UP/DOWN▲▼ buttons to select the desired item, then press the LEFT/RIGHT ◀▶ buttons.

Press the **RETURN** button to exit.

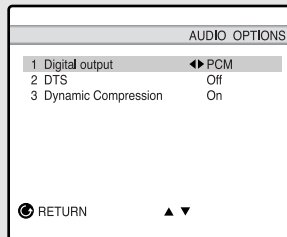

- **Digital output**
PCM: Converts to PCM(2CH) 48kHz/16Bit audio. Select PCM when using the Analog Audio Outputs.
Bitstream: Converts to Dolby Digital BITSTREAM - 5.1CH (if MPEG-2, 7.1CH). Select BITSTREAM when using the Digital Audio Output.
- **DTS**
On : Outputs DTS BITSTREAM via digital output only. Select DTS when connecting to a DTS DECODER.
Off : Doesn't output digital signal.
- **Dynamic Compression**
On : To select dynamic compression.
Off : To select the standard range.

Manufactured under license from Dolby Laboratories. "Dolby" and the double-D symbol are trademarks of Dolby Laboratories. Confidential unpublished works. ©1992-1997 Dolby Laboratories Inc. All rights reserved.

"DTS" and "DTS Digital Out" are trademarks of Digital Theater Systems, Inc.

Setting up the Display Options

- 1**
Press the **MENU** button.

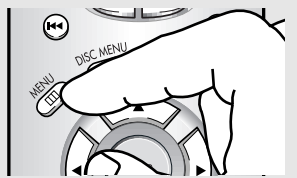

- 2**
Press the UP/DOWN▲▼ buttons to select "DVP Setup".
Press the LEFT/RIGHT◀▶ buttons.
The **SETUP MENU** is displayed.

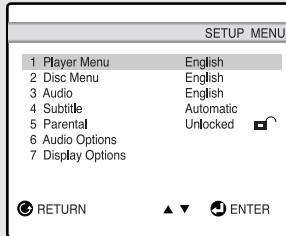

- 3**
Press the UP/DOWN▲▼ buttons to select "Display Options", then press the **ENTER** button.

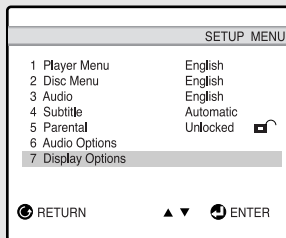

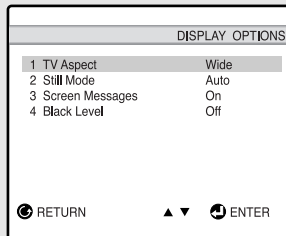

- 4**
Press the UP/DOWN▲▼ buttons to select the desired item, then press the LEFT/RIGHT◀▶ buttons. Press the **RETURN** button to exit.









- **TV Aspect**
 - 4:3 Letter Box : Select when you want to see the total 16:9 ratio screen DVD supplies, even though you have a TV with a 4:3 ratio screen. Black bars will appear at the top and bottom of the screen.
 - 4:3 Pan Scan : Select this for conventional size TVs when you want to see the central portion of the 16:9 screen. (Extreme left and right side of movie picture will be cut off.)
 - 16:9 Wide : You can view the full 16:9 picture on your widescreen TV.
- **Still Mode**
 - Field : Select this feature when the screen shakes in the Auto mode.
 - Frame : Select this feature when you want to see small letters more clearly in the Auto mode.
 - Auto : When selecting Auto, Field/Frame mode will be automatically converted.
- **Screen Messages**
Use to turn on-screen messages on or off.
- **Black Level**
Adjusts the brightness of the screen.(On/Off)

Disc Type and Characteristics

This DVD player is capable of playing the following types of discs with the corresponding logos:

Disc Types (Logos)	Recording Types	Disc Size	Max. Playing Time	Characteristics
DVD 	Audio + Video	5"	Single-sided 240 min. Double-sided 480 min.	<ul style="list-style-type: none"> DVD contains excellent sound and video due to Dolby Digital and MPEG-2 system. Various screen and audio functions can be easily selected through the on-screen menu.
		3 1/2"	Single-sided 80 min. Double-sided 160 min.	
VIDEO-CD 	Audio + Video	5"	74 min.	<ul style="list-style-type: none"> Video with CD sound, VHS quality & MPEG-1 compression technology.
		3 1/2"	20 min.	
AUDIO-CD 	Audio	5"	74 min.	<ul style="list-style-type: none"> CD is recorded as a Digital Signal with better audio quality, less distortion and less deterioration of audio quality over time.
		3 1/2"	20 min.	

Disc Markings

	• Play Region Number		• Digital Audio disc
	• NTSC broadcast system in U.S.A, Canada, Korea, Japan, etc.		• DTS disc
	• Dolby Digital disc		• MP3
	• Stereo disc		

Play Region Number

Both the DVD player and the discs are coded by region. These regional codes must match in order for the disc to play. If the codes do not match, the disc will not play.

Chapter Six

TROUBLESHOOTING

If the TV seems to have a problem, first try this list of possible problems and solutions. If none of these troubleshooting tips apply, then call your nearest service center.

Identifying Problems

Problem	Possible Solution
Poor picture	Try another channel. Adjust the antenna. Check all wire connections.
Poor sound quality	Try another channel. Adjust the antenna.
No picture or sound	Try another channel. Press the TV/VIDEO button. Make sure the TV is plugged in. Check the antenna connections.
No color, wrong colors or tints.	Make sure the program is broadcast in color. Adjust the picture settings. If the set is moved or turned in a different direction, the power should be OFF for at least 30 minutes.
Picture rolls vertically.	Adjust the antenna. Check all wire connections.
The TV operates erratically	Unplug the TV for 30 seconds, then try operating it again.
The TV won't turn on.	Make sure the wall outlet is working.
Disc does not play.	Ensure that the disc is installed with the label side facing up. Check the region number of the DVD. This player cannot play CD-ROMs, DVD-ROMs, CD-R, etc. Insert a DVD, a VIDEO-CD or a CD.
5.1 channel sound is not being reproduced.	5.1 channel sound is reproduced only when the following conditions are met. : 1) The DVD player is connected with the proper amplifier. 2) The disc is recorded with 5.1 channel sound. • Check whether the disc being played has the "Dolby 5.1 ch" mark on the outside. • Check if your audio system is connected and working properly.

Problem	Possible Solution
The  icon appears on screen.	The features or action cannot be completed at this time because : 1) The DVD's software restricts it. 2) The DVD's software doesn't support the feature (e.g., angles). 3) The feature is not available at the moment. 4) You've requested a title or chapter number or search time that is out of range.
Disc Menu doesn't appear.	Check if the disc has a Menu.
Playback mode differs from the Setup Menu selection.	Some of the functions selected in the Setup Menu may not work properly if the disc is not encoded with the corresponding function.
The screen ratio can not be changed.	The Screen Ratio is fixed on your DVDs.
No audio.	Make sure you have selected the correct Digital Output in the Audio Options Menu.
If you experience other problems.	Go to the contents and find the section of the instruction book that contains the explanations regarding the current problem, and follow the procedure once again. If the problem still cannot be solved, please contact your nearest authorized service center.

Cleaning and Maintaining Your TV

With proper care, your TV unit will give you many years of service. Please follow these guidelines to get the maximum performance from your TV.

Placement

- Do not place the TV near extremely hot, cold, humid or dusty places.
- Do not place the TV near appliances with electric motors that create magnetic fields, such as vacuum cleaners.
- Keep the ventilation openings clear; do not place the TV on a soft surface, such as cloth or paper.
- Place the TV in a vertical position only.

Liquids

- Do not handle liquids near or on the TV. Liquids that spill into it can cause serious damage.

Cabinet

- Never open the cabinet or touch the parts inside.
- Wipe your TV with a clean, dry cloth. Never use water, cleaning fluids, wax, or chemicals.
- Do not put heavy objects on top of the cabinet.

Temperature

- If your TV is suddenly moved from a cold to a warm place, unplug the power cord, and allow at least two hours for moisture that may have formed inside the unit to dry completely.

Using Your TV in Another Country

If you plan to take your TV with you to a foreign country, please be aware of the different television systems that are in use around the world. A TV designed for one system may not work properly with another system due to differences in the TV channel frequencies

Specifications

Model	CSN2077DV
Voltage	AC 120V
Frequency of Operation	60Hz
Power Consumption	80 watts
Dimension	606 x 513 x 505mm:23.86 x 20.20 x 19.88inches
Weight	29.5kg;65.04lbs

MEMO

MEMO

MEMO